

Enerlin'X IFE

Ethernet Switchboard Server

User Guide

12/2019



The information provided in this documentation contains general descriptions and/or technical characteristics of the performance of the products contained herein. This documentation is not intended as a substitute for and is not to be used for determining suitability or reliability of these products for specific user applications. It is the duty of any such user or integrator to perform the appropriate and complete risk analysis, evaluation and testing of the products with respect to the relevant specific application or use thereof. Neither Schneider Electric nor any of its affiliates or subsidiaries shall be responsible or liable for misuse of the information contained herein. If you have any suggestions for improvements or amendments or have found errors in this publication, please notify us.

You agree not to reproduce, other than for your own personal, noncommercial use, all or part of this document on any medium whatsoever without permission of Schneider Electric, given in writing. You also agree not to establish any hypertext links to this document or its content. Schneider Electric does not grant any right or license for the personal and noncommercial use of the document or its content, except for a non-exclusive license to consult it on an "as is" basis, at your own risk. All other rights are reserved.

All pertinent state, regional, and local safety regulations must be observed when installing and using this product. For reasons of safety and to help ensure compliance with documented system data, only the manufacturer should perform repairs to components.

When devices are used for applications with technical safety requirements, the relevant instructions must be followed.

Failure to use Schneider Electric software or approved software with our hardware products may result in injury, harm, or improper operating results.

Failure to observe this information can result in injury or equipment damage.

© 2019 Schneider Electric. All rights reserved.

Table of Contents



	Safety Information	5
	About the Book	7
Chapter 1	IFE Server Presentation	9
	Introduction	10
	Intelligent Modular Unit	11
	Hardware Description	13
	EcoStruxure Power Commission Software	17
	Schematics with MasterPact MTZ Circuit Breakers	18
	Schematics with MasterPact NT/NW and ComPact NS Circuit Breakers	20
	Schematics with ComPact NSX Circuit Breakers	24
	Technical Characteristics	29
	Firmware Update	30
	Schneider Electric Green Premium™ Ecolabel	31
Chapter 2	IFE Server Webpages	33
2.1	IFE Interface	34
	Access to IFE Webpages	35
	User Interface Layout	38
	Webpage Description	39
2.2	Configuration & Settings Webpages	41
	General	42
	Date and Time	43
	Time Zone	45
	Ethernet Configuration (Dual Port)	46
	IP Configuration	47
	Modbus TCP/IP Filtering	49
	Modbus Serial Line	50
	Email Server Configuration	51
	Email Events	53
	Device List	61
	Device Logging	65
	Device Log Export	67
	SNMP Parameters	68
	Preferences	69
	Advanced Services Control	70
	User Accounts	71
	Webpage Access	72
2.3	Monitoring Webpages	73
	Real Time Data	74
	Device Logging	76
2.4	Control Webpages	79
	Device Control	80
	Set Device Time	83
2.5	Diagnostics Webpages	84
	Statistics	85
	Device Identification	87
	IMU Information	88
	Read Device Registers	89
	Communication Check	90
	IO Readings	91

2.6	Maintenance Webpages	92
	Indicators	93
	Restore the Smartlink Modbus Devices	94
Appendices	95
Appendix A	Appendix A - List of IFE Supported Devices	97
	List of IFE Supported Device Types	97



Important Information

NOTICE

Read these instructions carefully, and look at the equipment to become familiar with the device before trying to install, operate, service, or maintain it. The following special messages may appear throughout this documentation or on the equipment to warn of potential hazards or to call attention to information that clarifies or simplifies a procedure.



The addition of this symbol to a “Danger” or “Warning” safety label indicates that an electrical hazard exists which will result in personal injury if the instructions are not followed.



This is the safety alert symbol. It is used to alert you to potential personal injury hazards. Obey all safety messages that follow this symbol to avoid possible injury or death.

DANGER

DANGER indicates a hazardous situation which, if not avoided, **will result in** death or serious injury.

WARNING

WARNING indicates a hazardous situation which, if not avoided, **could result in** death or serious injury.

CAUTION

CAUTION indicates a hazardous situation which, if not avoided, **could result in** minor or moderate injury.

NOTICE

NOTICE is used to address practices not related to physical injury.

PLEASE NOTE

Electrical equipment should be installed, operated, serviced, and maintained only by qualified personnel. No responsibility is assumed by Schneider Electric for any consequences arising out of the use of this material.

A qualified person is one who has skills and knowledge related to the construction and operation of electrical equipment and its installation, and has received safety training to recognize and avoid the hazards involved.

⚠ WARNING

POTENTIAL COMPROMISE OF SYSTEM AVAILABILITY, INTEGRITY, AND CONFIDENTIALITY

- Change default passwords at first use to help prevent unauthorized access to device settings, controls, and information.
- Disable unused ports/services and default accounts to help minimize pathways for malicious attackers.
- Place networked devices behind multiple layers of cyber defenses (such as firewalls, network segmentation, and network intrusion detection and protection).
- Use cybersecurity best practices (for example, least privilege, separation of duties) to help prevent unauthorized exposure, loss, modification of data and logs, or interruption of services.

Failure to follow these instructions can result in death, serious injury, or equipment damage.

About the Book



At a Glance

Document Scope

The aim of this document is to provide the users, installers, and the maintenance personnel with the technical information and procedure needed to access and maintain the IFE Ethernet switchboard server webpages.

Validity Note

The information contained in this document is likely to be updated at any time. Schneider Electric strongly recommends that you have the most recent and up-to-date version available on www.schneider-electric.com/docs.

The technical characteristics of the devices described in the present document also appear online. To access the information online:

Step	Action
1	Go to the Schneider Electric home page www.schneider-electric.com .
2	In the Search box type the reference of a product or the name of a product range. <ul style="list-style-type: none">Do not include blank spaces in the reference or product range.To get information on grouping similar modules, use asterisks (*).
3	If you entered a reference, go to the Product Datasheets search results and click on the reference that interests you. If you entered the name of a product range, go to the Product Ranges search results and click on the product range that interests you.
4	If more than one reference appears in the Products search results, click on the reference that interests you.
5	Depending on the size of your screen, you may need to scroll down to see the datasheet.
6	To save or print a datasheet as a .pdf file, click Download XXX product datasheet .

The characteristics that are presented in the present document should be the same as those characteristics that appear online. In line with our policy of constant improvement, we may revise content over time to improve clarity and accuracy. If you see a difference between the document and online information, use the online information as your reference.

Related Documents

Title of Documentation	Reference Number
Enerlin'X IFE - Ethernet Switchboard Server - Instruction Sheet	QGH13473
MasterPact MTZ Modbus Communication Guide	DOCA0105EN
MasterPact NT/NW, ComPact NS Modbus Communication Guide	DOCA0054EN
ComPact NSX Modbus Communication Guide	DOCA0091EN
ULP System (IEC Standard) - User Guide	DOCA0093EN
Enerlin'X IFE/EIFE Firmware Release Note	DOCA0147EN

You can download these technical publications and other technical information from our website at <https://www.se.com/ww/en/download/>.

Trademark Notice

All trademarks are owned by Schneider Electric Industries SAS or its affiliated companies

Chapter 1

IFE Server Presentation

What Is in This Chapter?

This chapter contains the following topics:

Topic	Page
Introduction	10
Intelligent Modular Unit	11
Hardware Description	13
EcoStruxure Power Commission Software	17
Schematics with MasterPact MTZ Circuit Breakers	18
Schematics with MasterPact NT/NW and ComPact NS Circuit Breakers	20
Schematics with ComPact NSX Circuit Breakers	24
Technical Characteristics	29
Firmware Update	30
Schneider Electric Green Premium™ Ecolabel	31

Introduction

Overview

The IFE Ethernet switchboard server (or IFE server) enables an intelligent modular unit (IMU) with a ComPact™, PowerPact™, or MasterPact™ circuit breaker to be connected to an Ethernet network. Each circuit breaker has its own IFE server and a corresponding IP address.

The IFE server with part number LV434002 is an Ethernet switchboard server for ComPact, PowerPact, and MasterPact circuit breakers and a server for Modbus-SL (serial line) connected devices.

NOTE: The IFE server with part number LV434002 completely replaces the IFE server with part number LV434011. The LV434002 comes with the real time clock (RTC) feature and allows ULP connections up to 20 m (65.6 ft) with the MasterPact MTZ circuit breakers (LV434011 had a theoretical limitation of 5 m (16.4 ft) over the life of the IFE server)

IFE Server Features

The main features of IFE server are:

- Dual Ethernet port for simple daisy chain connection
- Device profile web service for discovery of the IFE server on the local area network (LAN)
- ULP compliant for location of the IFE server in the switchboard
- Ethernet interface for ComPact, PowerPact, and MasterPact circuit breakers
- Server for Modbus-SL connected devices
- Embedded setup webpages
- Embedded monitoring webpages
- Embedded control webpages
- Built-in email alarm notification for circuit breaker connected to IFE server.

NOTE: The built-in switch of IFE server does not support the ring topology as it does not have the feature of the loop back protection.

Intelligent Modular Unit

Definition

A modular unit is a mechanical and electrical assembly containing one or more products to perform a function in a switchboard (incoming protection, motor command, and control).

The circuit breaker with its internal communicating components (MicroLogic control unit or MicroLogic trip unit) and external ULP modules (IO module) connected to one communication interface is called an intelligent modular unit (IMU).

An IMU is composed around a circuit breaker from the following ranges:

- MasterPact MTZ circuit breakers
- MasterPact NT/NW circuit breakers
- ComPact NS 1600b-3200 circuit breakers
- ComPact NS 630b-1600 circuit breakers
- PowerPact P- and R- frame circuit breakers
- ComPact NSX circuit breakers
- PowerPact H-, J-, and L- frame circuit breakers

ULP Modules Per Circuit Breaker Range

The following table lists the compatible ULP modules for each range of circuit breakers.

ULP Module	Part Number	MasterPact MTZ with ULP Port Module and MicroLogic Control Unit	MasterPact NT/NW or ComPact NS or PowerPact P- and R- Frame with BCM ULP Module and MicroLogic Trip Unit	ComPact NSX or PowerPact H-, J-, and L- Frame with BSCM Module and/or MicroLogic Trip Unit
IFE Ethernet interface for one circuit breaker	LV434001 LV434010	✓	✓	✓
IFE Ethernet switchboard server	LV434002 LV434011	✓	✓	✓
EIFE Embedded Ethernet interface for one MasterPact MTZ drawout circuit breaker	LV851001	✓	–	–
Spare part kit EIFE for one MasterPact MTZ1 drawout circuit breaker	LV851100SP	✓	–	–
Spare part kit EIFE for one MasterPact MTZ2/MTZ3 drawout circuit breaker	LV851200SP	✓	–	–
IFM Modbus-SL interface for one circuit breaker	TRV00210 STRV00210	–	✓	✓
IFM Modbus-SL interface for one circuit breaker	LV434000	✓	✓	✓
FDM121 front display module for one circuit breaker	TRV00121 STRV00121	–	✓	✓
IO input/output application module for one circuit breaker	LV434063	✓	✓	✓
USB maintenance interface	TRV00911 STRV00911	–	✓	✓

For more information on the ULP System and its components, refer to the *ULP System User Guides*.

Communication Architecture

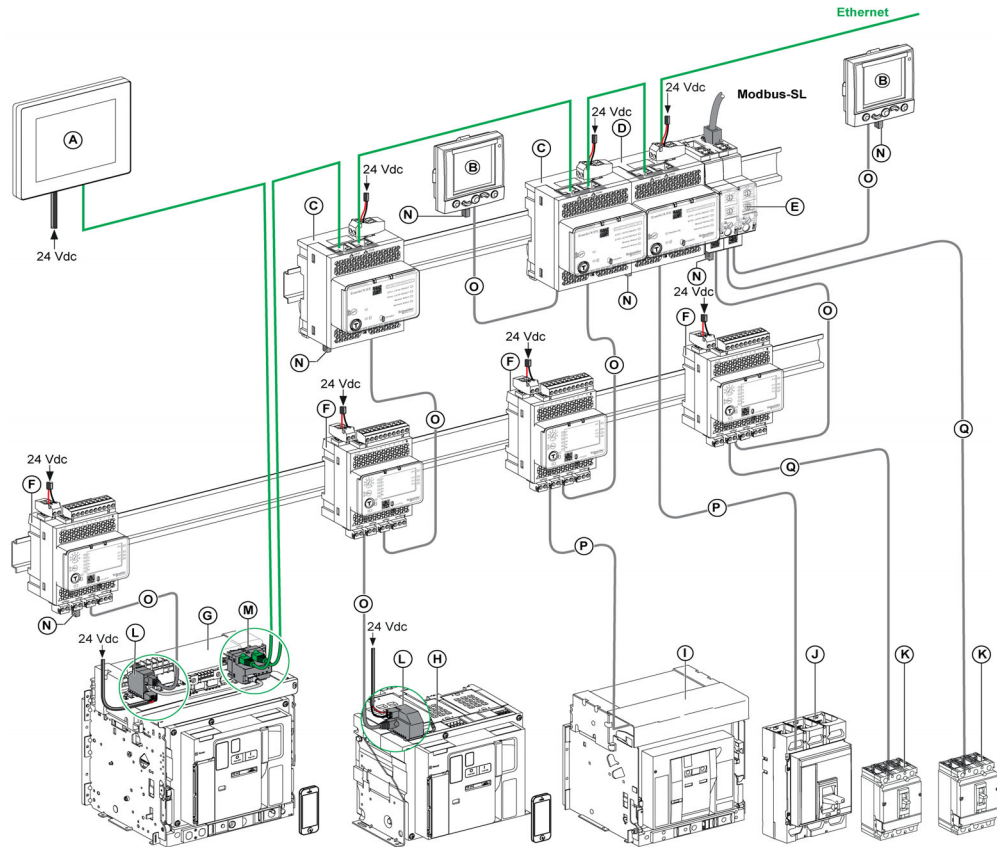

- A FDM128 Ethernet display for eight devices
- B FDM121 front display module for one circuit breaker
- C IFE Ethernet interface for one circuit breaker
- D IFE Ethernet switchboard server
- E IFM Modbus-SL interface for one circuit breaker
- F IO input/output application module for one circuit breaker
- G MasterPact MTZ1 or MTZ2/MTZ3 drawout circuit breaker
- H MasterPact MTZ1 or MTZ2/MTZ3 fixed circuit breaker
- I MasterPact NT/NW circuit breaker
- J ComPact NS/PowerPact M-, P-, and R-frame circuit breaker
- K ComPact NSX/PowerPact H-, J-, and L-frame circuit breaker
- L ULP port module
- M EIFE Embedded Ethernet Interface for one MasterPact MTZ drawout circuit breaker
- N ULP line termination
- O RJ45 male/male ULP cord
- P Circuit breaker BCM ULP cord
- Q NSX cord

Remote Controller

A remote controller is a device that is able to communicate with an IMU using a communication interface, such as the IFE server. For example, FDM128 Ethernet display for eight devices, supervisor, PLC, BMS, SCADA system, and so on, are remote controllers.

For the description of Modbus registers and commands, refer to the *Modbus Communication Guides*.

Hardware Description

Description

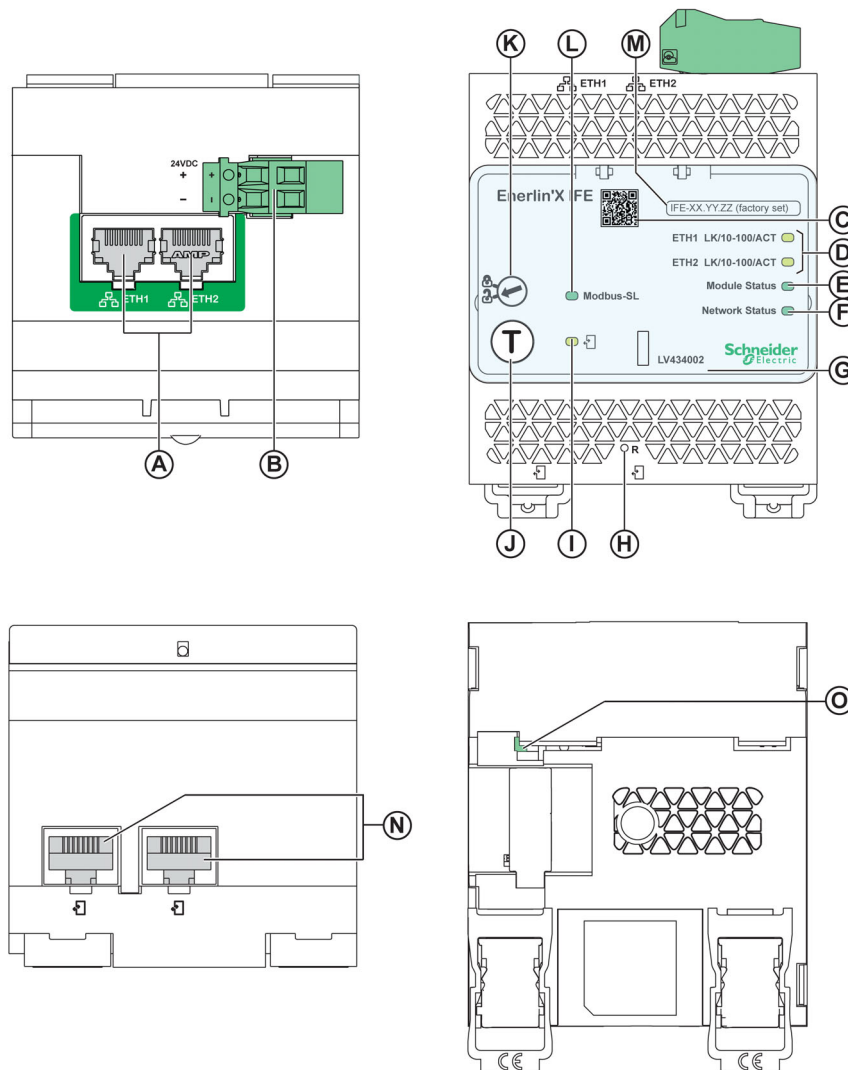

- A Ethernet 1 and Ethernet 2 RJ45 communication ports
- B 24 Vdc power supply terminal block
- C QR code to product information
- D Ethernet communication LEDs
- E Module status LED
- F Network status LED
- G Sealable transparent cover
- H Reset button
- I ULP status LED
- J Test button (accessible even with closed cover)
- K Locking pad
- L Modbus traffic status LED (IFE server only)
- M Device name label
- N Two RJ45 ULP ports
- O Grounding connection

For information on installation, consult the instruction sheet available on the Schneider Electric website: [QGH13473](#).

Mounting

The IFE server mounts on a DIN rail. The stacking accessory enables the connection of several IFM interfaces to an IFE server without additional wiring.

24 Vdc Power Supply

The IFE server must always be supplied with 24 Vdc. The power to the IFM interfaces stacked to an IFE server are supplied by the IFE server and it is not necessary to supply power to them separately.

It is recommended to use an UL listed and recognized limited voltage/limited current or a class 2 power supply with a 24 Vdc, 3 A maximum.

NOTE: For 24 Vdc power supply connection, use copper conductors only.

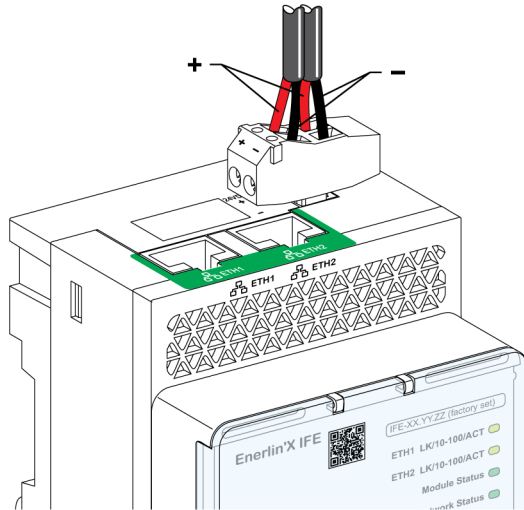

Ethernet Communication LEDs

The Ethernet communication dual color LEDs, indicate the status of the Ethernet ports **ETH1** and **ETH2**.

LED Indication	Status Description
OFF	No power or no link
Steady yellow	10 Mbps, link established, and no activity
Blinking yellow	10 Mbps, ongoing activity
Steady green	100 Mbps, link established, and no activity
Blinking green	100 Mbps, ongoing activity

Module Status LED

The module status dual color LED, indicates the IFE server status.

LED Indication	Status Description	Action
OFF	No power	None
Steady green	IFE server operational	None
Blinking green (250 ms ON, 250 ms OFF)	Hidden control webpage available	None
Blinking green (500 ms ON, 500 ms OFF)	IFE server firmware corrupted	Contact your local Schneider Electric service team for support.
Blinking red (500 ms ON, 500 ms OFF)	IFE server in degraded mode	Replace ULP module at the next maintenance operation.
Steady red	IFE server out of service	None
Blinking green/red (1 s green, 1 s red)	Firmware update in progress	None
Blinking green/red (250 ms green, 250 ms red)	Self-test in progress	None

Network Status LED

The network status dual color LED, indicates the Ethernet network status.

LED Indication	Status Description
OFF	No power or no IP address
Steady green	Valid IP address
Steady red	Duplicated IP address
Blinking green/red (250 ms green, 250 ms red)	Self-test in progress
Steady amber	Error in IP configuration

Modbus Serial Line Traffic LED

The Modbus serial line traffic yellow LED, indicates that the traffic is being transmitted or received over the Modbus serial line network through the IFE server.

The LED is ON during the transmission and reception of the messages. The LED is OFF otherwise.

Modbus Address

The IFE server accepts the Modbus address of the IMU to which it is connected.

The Modbus address is 255 and cannot be changed.

Locking Pad

The locking pad on the front panel of the IFE server enables or disables the ability to send the remote control commands over the Ethernet network to the IFE server, and to the other modules of the IMU

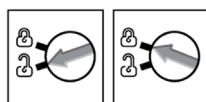

- If the arrow points to the open padlock (factory setting), remote control commands are enabled.
- If the arrow points to the closed padlock, remote control commands are disabled.
The only remote control command that is enabled even if the arrow points to the closed padlock, is the set absolute time command.

Test Button

The test button has two functions, according to the duration of the button pressed.

Time Range	Function
1–5 s	Tests the connection between all the ULP modules for 15 s.
10–15 s	Activates the hidden configuration mode. NOTE: The hidden configuration is not activated if the button is pressed for more than 15 s.

Reset Button

When the reset button is pressed for 1–5 s, it forces the IP acquisition mode to the factory default setting (DHCP).

ULP Status LED

The yellow ULP status LED describes the mode of the ULP module.

ULP LED	Mode	Action
	Nominal	None
	Conflict	Remove extra ULP module
	Degraded	Replace ULP module at the next maintenance operation
	Test	None
	Non-critical firmware discrepancy	Use EcoStruxure Power Commission software to check the firmware and hardware compatibility and follow the recommended actions
	Non-critical hardware discrepancy	
	Configuration discrepancy	Install missing features
	Critical firmware discrepancy	Use EcoStruxure Power Commission software to check the firmware and hardware compatibility and follow the recommended actions
	Critical hardware discrepancy	
	Stop	Replace ULP module
	Power OFF	Check power supply

EcoStruxure Power Commission Software

Overview

EcoStruxure™ Power Commission is the new name of Ecoeach software.

EcoStruxure Power Commission software helps you to manage a project as part of testing, commissioning, and maintenance phases of the project life cycle. The innovative features in it provide simple ways to configure, test, and commission the smart electrical devices.

EcoStruxure Power Commission software automatically discovers the smart devices and allows you to add the devices for an easy configuration. You can generate comprehensive reports as part of Factory Acceptance Test and Site Acceptance Test to replace your heavy manual work. Additionally, when the panels are under operation, any change of settings made can be easily identified by a yellow highlighter. This indicates the difference between the project and device values, and hence provides a system consistency during the operation and maintenance phase.

EcoStruxure Power Commission software enables the configuration of the following circuit breakers, modules, and accessories:

Circuit breaker ranges	Modules	Accessories
MasterPact MTZ circuit breakers	<ul style="list-style-type: none"> MicroLogic X control unit Communication interface modules: IFM interface, IFE interface, IFE server, and EIFE interface ULP modules: IO module 	M2C output module
<ul style="list-style-type: none"> MasterPact NT/NW circuit breakers ComPact NS circuit breakers PowerPact P- and R-frame circuit breakers 	<ul style="list-style-type: none"> MicroLogic trip units Communication interface modules: BCM module, CCM module, BCM ULP module, IFM interface, IFE interface, IFE server ULP modules: IO module, FDM121 display⁽¹⁾ 	M2C and M6C output modules
<ul style="list-style-type: none"> ComPact NSX circuit breakers PowerPact H-, J- and L-frame circuit breakers 	<ul style="list-style-type: none"> MicroLogic trip units Communication interface modules: BSCM module, IFM interface, IFE interface, IFE server ULP modules: IO module, FDM121 display⁽¹⁾ 	SDTAM and SDx output modules

(1) For FDM121 display, only the firmware and language download are supported.

For more information, refer to the *EcoStruxure Power Commission Online Help*.

EcoStruxure Power Commission software is available at www.schneider-electric.com

Key Features

EcoStruxure Power Commission software performs the following actions for the supported devices and modules:

- Create projects by device discovery
- Save the project in the EcoStruxure Power Commission cloud for reference
- Upload settings to the device and download settings from the device
- Compare the settings between the project and the device
- Perform control actions in a secured way
- Generate and print the device settings report
- Perform a communication wiring test on the entire project and generate and print test report
- View the communication architecture between the devices in a graphical representation
- View the measurements, logs, and maintenance information
- Export Waveform Capture on Trip Event (WFC)
- View the status of device and IO module
- View the alarm details
- Buy, install, remove, or retrieve the Digital Modules
- Check the system firmware compatibility status
- Update to the latest device firmware
- Perform force trip and automatic trip curve tests

Schematics with MasterPact MTZ Circuit Breakers

Description

The IFE server is connected to the MasterPact MTZ circuit breaker through its ULP port module. For more information, refer to the *ULP System User Guides*.

ULP Connection

<i>NOTICE</i>
HAZARD OF EQUIPMENT DAMAGE <ul style="list-style-type: none">• Never connect an Ethernet device to an RJ45 ULP port.• The RJ45 ULP ports of IFE server are for ULP modules only.• Any other use can damage the IFE server or the device connected to the IFE server.• To check if an ULP module is compatible with the RJ45 ULP ports of IFE server, refer to the <i>ULP System User Guides</i>. Failure to follow these instructions can result in equipment damage.

All the connection configurations require the RJ45 male/male ULP cord. When the second RJ45 ULP port is not used, it must be closed with an ULP line termination.

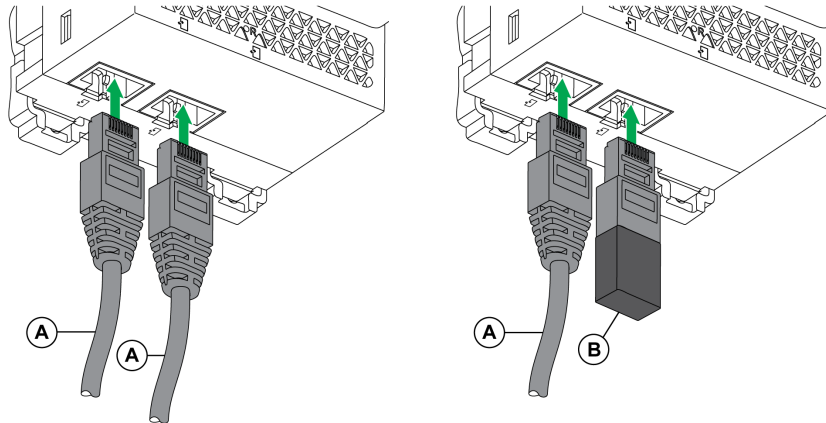

- A** RJ45 male/male ULP cord
- B** ULP line termination

Connection of the IFE Server to a MasterPact MTZ Circuit Breaker

Connect the IFE server to the ULP port module on a MasterPact MTZ circuit breaker by using the ULP cord.

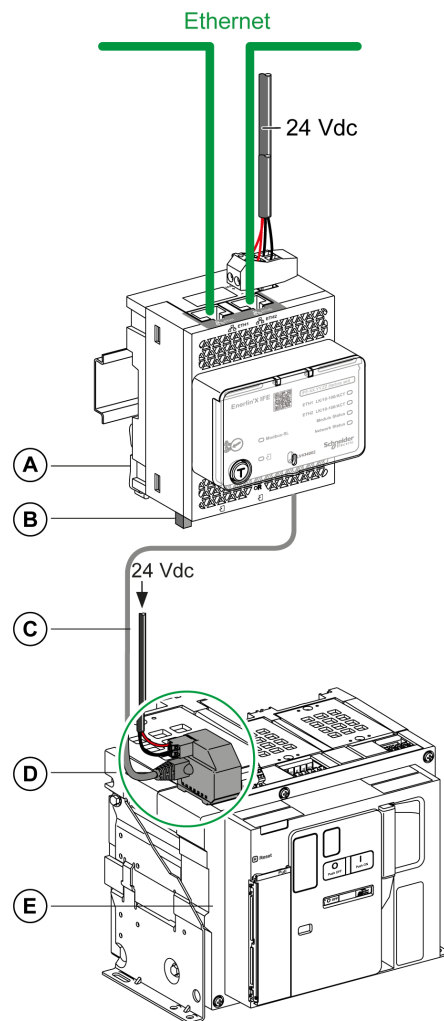

- A IFE Ethernet switchboard server
- B ULP line termination
- C RJ45 male/male ULP cord
- D ULP port module
- E MasterPact MTZ fixed circuit breaker

Schematics with MasterPact NT/NW and ComPact NS Circuit Breakers

Description

Depending on the type of circuit breaker used, connect the IFE server to the circuit breaker using one of the following configurations:

- Connection of the IFE server to a fixed manually-operated ComPact NS circuit breaker with a BCM ULP module.
- Connection of the IFE server to a fixed electrically-operated MasterPact NT/NW or ComPact NS 630b-1600 circuit breaker with a BCM ULP module.
- Connection of the IFE server to a drawout MasterPact NT/NW or ComPact NS 630b-1600 circuit breaker with a BCM ULP module and its respective IO module.

For more information, refer to the *ULP System User Guide*.

ULP Connection

<i>NOTICE</i>
HAZARD OF EQUIPMENT DAMAGE
<ul style="list-style-type: none">• Never connect an Ethernet device to a RJ45 ULP port.• The RJ45 ULP ports of IFE server are for ULP modules only.• Any other use can damage the IFE server or the device connected to the IFE server.• To check if a ULP module is compatible with the RJ45 ULP ports of IFE server, refer to the <i>ULP System User Guide</i>.
Failure to follow these instructions can result in equipment damage.

All connection configurations require the BCM ULP cord.

When the second RJ45 ULP port is not used, it must be closed with a ULP line termination.

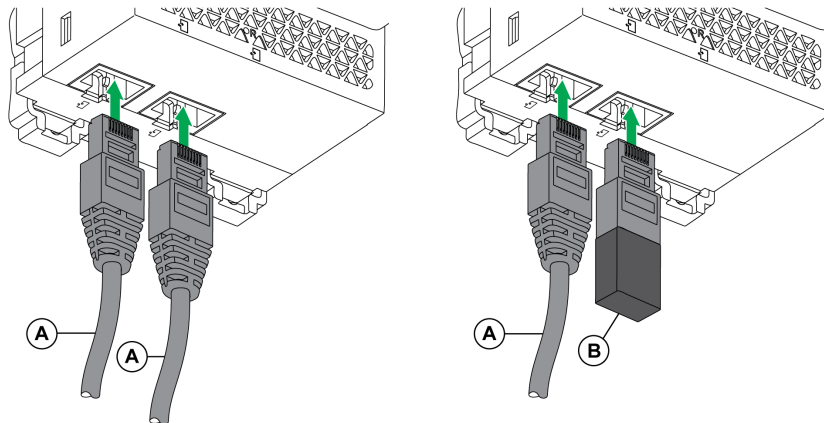

- A** Circuit breaker BCM ULP cord or RJ45 male/male ULP cord
- B** ULP line termination

Connection of the IFE Server to a Fixed Manually-Operated ComPact NS Circuit Breaker

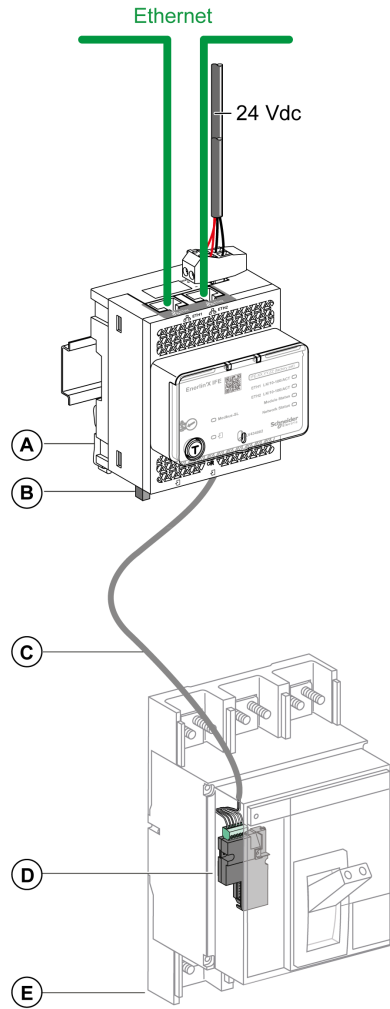

- A IFE Ethernet switchboard server
- B ULP line termination
- C Circuit breaker BCM ULP cord
- D BCM ULP circuit breaker communication module
- E Fixed manually-operated ComPact NS circuit breaker

Connection of the IFE Server to a Fixed Electrically-Operated MasterPact NT/NW or ComPact NS 630b-1600 Circuit Breaker

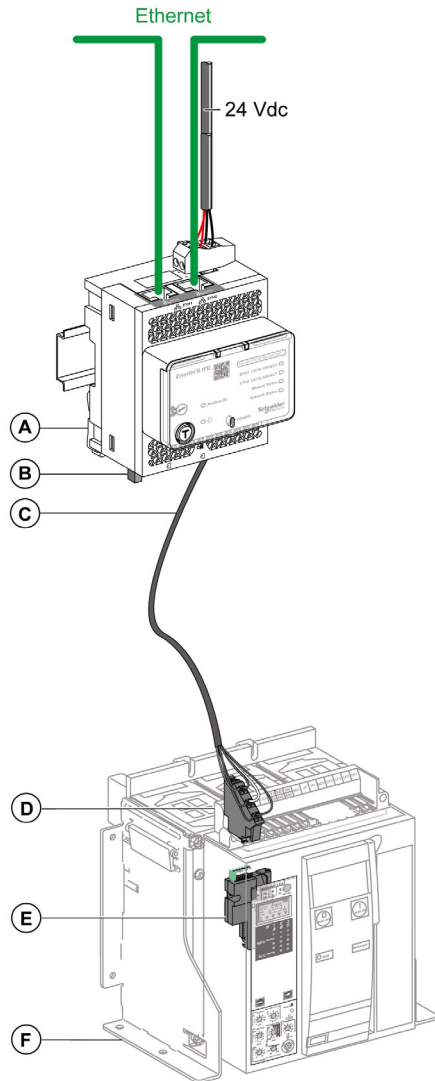

- A IFE Ethernet switchboard server
- B ULP line termination
- C Circuit breaker BCM ULP cord
- D Fixed terminal block
- E BCM ULP circuit breaker communication module
- F Fixed electrically-operated circuit breaker

Connection of the IFE Server to a Drawout MasterPact NT/NW or ComPact NS 630b-1600 Circuit Breaker

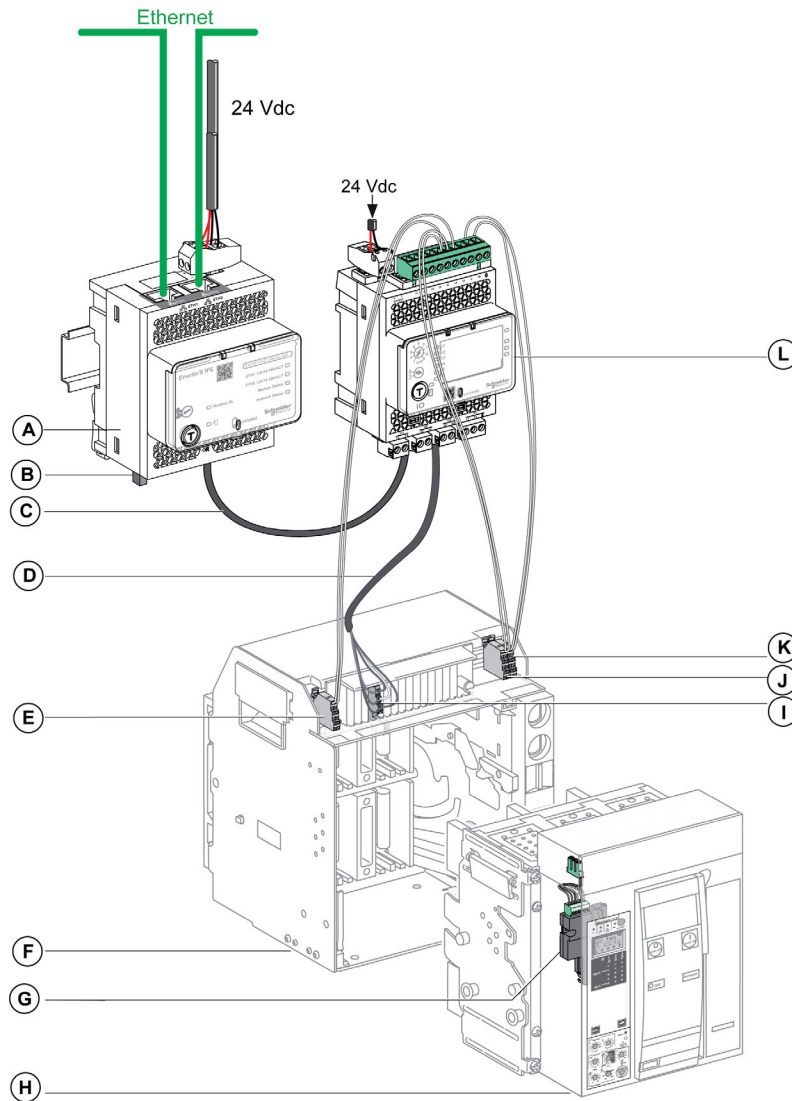

- A IFE Ethernet switchboard server
- B ULP line termination
- C RJ45 male/male ULP cord
- D Circuit breaker BCM ULP cord
- E Circuit breaker disconnected position contact (CD)
- F Circuit breaker cradle
- G BCM ULP circuit breaker communication module
- H Drawout circuit breaker
- I Drawout terminal block
- J Circuit breaker connected position contact (CE)
- K Circuit breaker test position contact (CT)
- L IO input/output application module for one circuit breaker

Schematics with ComPact NSX Circuit Breakers

General Description

Depending on the configuration of the ComPact NSX circuit breaker, connect the IFE server to the circuit breaker using one of the following configurations:

- Connection of the IFE server to the MicroLogic trip unit
- Connection of the IFE server to the BSCM module
- Connection of the IFE server to the BSCM module and to the MicroLogic trip unit

For more information, refer to the *ULP System User Guide*.

ULP Connection

⚠ WARNING
HAZARD OF ELECTRIC SHOCK
For system voltage greater than 480 Vac: <ul style="list-style-type: none">• Use the insulated NSX cord LV434204.• Do not use NSX cords LV434200, LV434201, and LV434202.
Failure to follow these instructions can result in death, serious injury, or equipment damage.

NOTICE
HAZARD OF EQUIPMENT DAMAGE
<ul style="list-style-type: none">• Never connect an Ethernet device to an RJ45 ULP port.• The RJ45 ULP ports of IFE server are for ULP modules only.• Any other use can damage the IFE server or the device connected to the IFE server.• To check if an ULP module is compatible with the RJ45 ULP ports of IFE server, refer to the <i>ULP System User Guide</i>.
Failure to follow these instructions can result in equipment damage.

All connection configurations require the NSX cord. The insulated NSX cord is mandatory for system voltages greater than 480 Vac.

When the second RJ45 ULP port is not used, it must be closed with an ULP line termination.

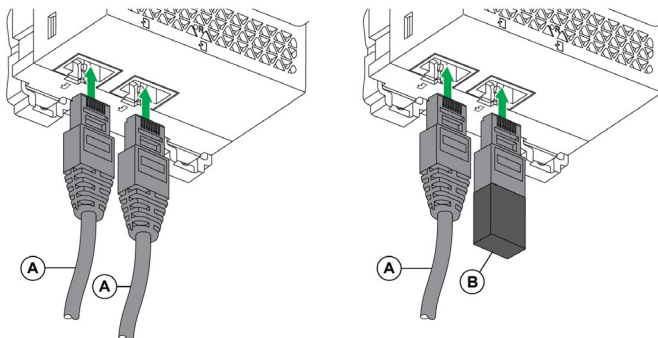

- A** NSX cord or RJ45 male/male ULP cord
- B** ULP line termination

Connection of the IFE Server to the MicroLogic Trip Unit

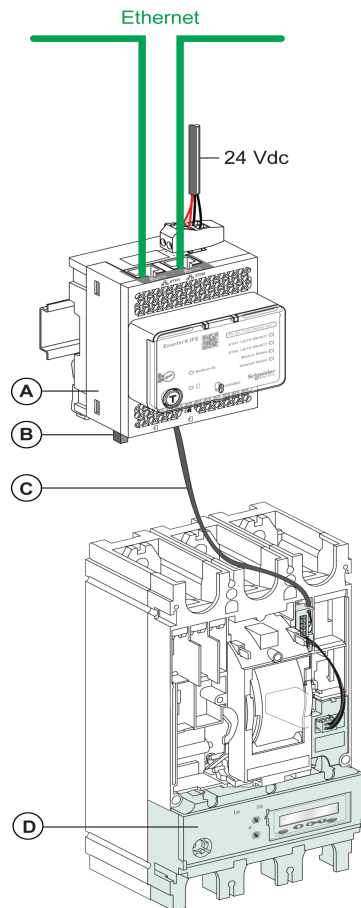

- A IFE Ethernet switchboard server
- B ULP line termination
- C NSX cord
- D MicroLogic trip unit

Connection of the IFE Server to the BSCM Module

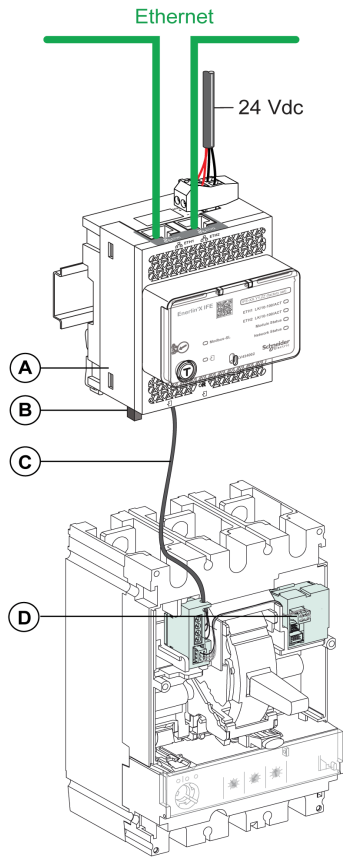

- A IFE Ethernet switchboard server
- B ULP line termination
- C NSX cord
- D BSCM breaker status control module

Connection of the IFE Server to the BSCM Module and to the MicroLogic Trip Unit

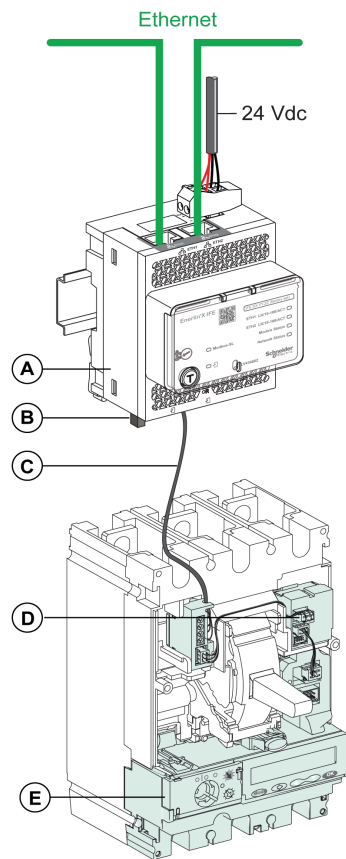

- A IFE Ethernet switchboard server
- B ULP line termination
- C NSX cord
- D BSCM breaker status control module
- E MicroLogic trip unit

Connection of the IFE Server to a Circuit Breaker for System Voltage Greater Than 480 Vac

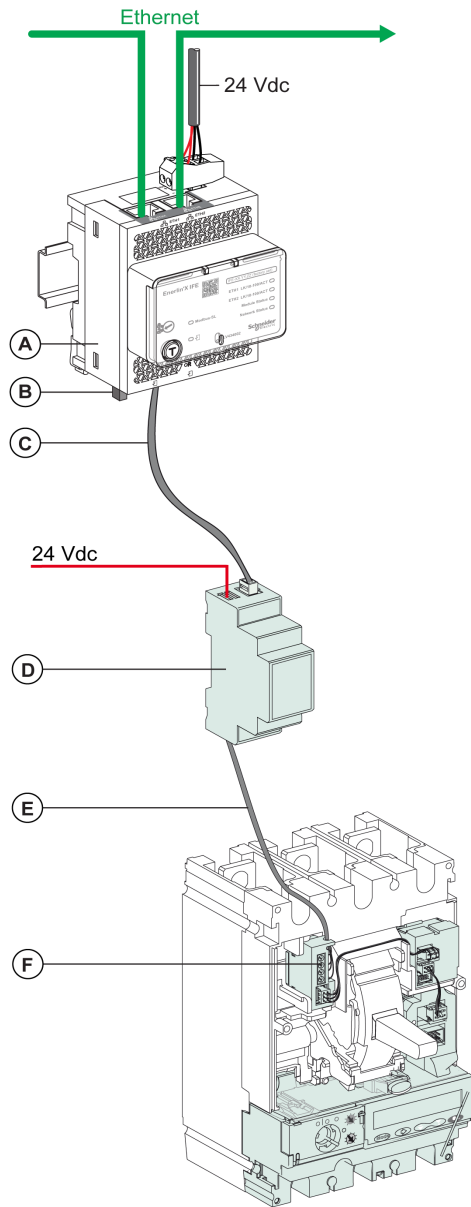

- A** IFE Ethernet switchboard server
- B** ULP line termination
- C** RJ45 male/male ULP cord
- D** Insulated ULP module for system voltage greater than 480 Vac
- E** Insulated ULP cord for system voltage greater than 480 Vac
- F** Connector for ComPact NSX internal connection

Technical Characteristics

Environmental Characteristics

Characteristics		Value
Conforming to standards		<ul style="list-style-type: none"> • IACS E10 • EN 61326-1 • CSA C22.2 • IEC/UL 61010-2-201 • IEC61000-6-2 Ed.2
Certification		cULus, CE, EAC, and FCC marking
Ambient temperature	Storage	-40 °C to +85 °C (-40 °F to +185 °F)
	Operation	-25 °C to +70 °C (-13 °F to +158 °F)
Protective treatment		ULV0, conforming to IEC/EN 60068-2-30
Pollution		Level 3

Mechanical Characteristics

Characteristics	Value
Shock resistance	Conforming to IEC 60068-2-27 15 g/11 ms, 1/2 sinusoidal
Resistance to sinusoidal vibrations	Conforming to IEC/EN 60068-2-6

Electrical Characteristics

Characteristics		Value
Power supply		24 Vdc, -20%/+10% (19.2–26.4 Vdc)
Consumption	Typical	24 Vdc, 120 mA at 20 °C (68 °F)
	Maximum with server	19.2 Vdc, 140 mA at 60 °C (140 °F)

Physical Characteristics

Characteristics	Value
Dimensions	72 x 105 x 71 mm (2.83 x 4.13 x 2.79 in)
Mounting	DIN rail
Weight	187 g (0.41 lb)
Degree of protection of the installed module	<ul style="list-style-type: none"> • On the front panel (wall-mounted enclosure): IP4x • Connectors: IP2x • Other parts: IP3x
Connections	Screw type terminal blocks

24 Vdc Power Supply Characteristics

It is recommended to use an UL listed/UL recognized limited voltage/limited current or a class 2 power supply with a 24 Vdc, 3 A maximum.

NOTE: For 24 Vdc power supply connection, use copper conductors only.

For more information, refer to the *ULP System User Guide*.

Characteristics	Value
Power supply type	Regulated switch type
Rated power	72 W
Input voltage	100–120 Vac for single phase
	200–500 Vac phase-to-phase
PFC filter	With IEC 61000-3-2
Output voltage	24 Vdc
Power supply output current	3 A

Firmware Update

Description

Use the latest version of EcoStruxure Power Commission software for all firmware updates. The latest version of IFE firmware and IFE webpages are updated in a single operation through EcoStruxure Power Commission software. For more information on IFE firmware versions, refer to *Enerlin'X IFE Firmware Release Note*.

⚠ WARNING
<p>LOSS OF DATA</p> <p>Backup the data log files before updating the firmware.</p> <p>The data log entries of the IFE server may be lost when the IFE firmware is updated.</p> <p>Failure to follow these instructions can result in death, serious injury, or equipment damage.</p>

After updating the firmware of one device in the IMU, use the latest version of EcoStruxure Power Commission software to check the firmware compatibility between the IMU devices. The **Firmware Update** table helps you to diagnose and identify all discrepancy issues between the IMU devices. This table also provides the recommended actions relevant to the detected discrepancies.

Checking the Firmware Version

- You can find the firmware version of the devices in the IMU by using:
- EcoStruxure Power Commission software, refer to the *EcoStruxure Power Commission Online Help*.
 - IFE webpages, see the procedure below.

Step	Action	Result
1	Open the web browser and log in to the IFE webpage.	Opens the IFE home page.
2	<p>Locate the firmware version on Device Information page on the Diagnostics menu (<i>see page 87</i>).</p> <p>NOTE: If you have updated the firmware recently, press F5 to refresh the webpage and update the displayed firmware number.</p>	Determines the firmware version of the IFE server.

Updating the Firmware and Webpages, Using EcoStruxure Power Commission Software

For more information, refer to the *EcoStruxure Power Commission Online Help*. The EcoStruxure Power Commission software is available at www.schneider-electric.com.

Schneider Electric Green Premium™ Ecolabel

Description

Green Premium by Schneider Electric is a label that allows you to develop and promote an environmental policy while preserving your business efficiency. This ecolabel is compliant with up-to-date environmental regulations.



Accessing Green Premium

Green Premium data on labeled products can be accessed online through any of the following ways:

- By navigating to the [Green Premium](#) page on the Schneider Electric website.
- By flashing the QR code displayed in the following image:



Checking Products Through the Schneider Electric Website

To check the environmental criteria of a product using a PC or smartphone, follow these steps:

Step	Action
1	From www.schneider-electric.com , select Support → Additional Links → Green Premium Eco Label .
2	Click Find Green Premium Products to open the search tool webpage.
3	Fill in the fields: <ul style="list-style-type: none"> • Enter the commercial reference or product range of the product to search for. • Optional: Enter the manufacturing date code of the product with format YYWW. By default, this field is filled with the date of the search.
4	To search for several products simultaneously, click the Add product button, and then fill in the fields.
5	Click Check product(s) to generate a report of the environmental criteria available for the products with the entered commercial references.

Environmental Criteria

The Green Premium ecolabel provides documentation on the following criteria about the environmental impact of the products:

- RoHs: European Union Restriction of Hazardous Substances (RoHS) directive.
- REACH: European Union Registration, Evaluation, Authorization, and Restriction of Chemicals regulation.
- PEP: Product Environmental Profile.
- EoLI: End of Life Instructions.

RoHs

Schneider Electric products are subject to RoHS requirements at a worldwide level, even for the many products that are not required to comply with the terms of the regulation. Compliance certificates are available for products that fulfill the criteria of this European initiative, which aims to eliminate hazardous substances.

REACH

Schneider Electric applies the strict REACH regulation on its products at a worldwide level, and discloses extensive information concerning the presence of SVHC (Substances of Very High Concern) in all of these products.

PEP

Schneider Electric publishes complete set of environmental data, including carbon footprint and energy consumption data for each of the life cycle phases on all of its products, in compliance with the ISO 14025 PEP ecopassport program. PEP is especially useful for monitoring, controlling, saving energy, and/or reducing carbon emissions.

EoLI

These instructions provide:

- Recyclability rates for Schneider Electric products.
- Guidance to mitigate personnel hazards during the dismantling of products and before recycling operations.
- Part identification for recycling or for selective treatment, to mitigate environmental hazards/incompatibility with standard recycling processes.

Chapter 2

IFE Server Webpages

What Is in This Chapter?

This chapter contains the following sections:

Section	Topic	Page
2.1	IFE Interface	34
2.2	Configuration & Settings Webpages	41
2.3	Monitoring Webpages	73
2.4	Control Webpages	79
2.5	Diagnostics Webpages	84
2.6	Maintenance Webpages	92

Section 2.1

IFE Interface

What Is in This Section?

This section contains the following topics:

Topic	Page
Access to IFE Webpages	35
User Interface Layout	38
Webpage Description	39

Access to IFE Webpages

Supported Web Browsers

Browser	Version with Windows XP	Version with Windows Vista	Version with Windows 7 and later
Internet Explorer	IE 9.0	IE 9.0	IE 10.0, IE11.0
Firefox	15.0	20.0	20.0, 45.0
Chrome (recommended)	24.0 and later	24.0 and later	24.0 and later

First Access to the IFE Webpages

The IFE name must be configured during the first access to the IFE webpages.

 WARNING
<p>POTENTIAL COMPROMISE OF SYSTEM AVAILABILITY, INTEGRITY, AND CONFIDENTIALITY</p> <p>Change default passwords at first use to help prevent unauthorized access to device settings, controls, and information.</p> <p>Failure to follow these instructions can result in death, serious injury, or equipment damage.</p>

The procedure to access the IFE webpages for the first time depends on the operating system of the PC:

- Windows Vista, Windows 7 and later, or newer operating systems
- Windows XP or older operating systems

NOTE: After updating the IFE server, delete the browser cache before accessing the webpages for the first time.

First Access Through PC with Windows Vista or Windows 7 and Later

Step	Action
1	Disconnect the PC from the local area network (LAN) and switch off Wi-Fi.
2	Connect an Ethernet cable from the PC to the IFE server or to the Ethernet switch inside the panel.
3	Open Windows Explorer .
4	Click Network and the IFE-XXYYZZ appears in the list of devices. NOTE: If the IFE name is not displayed in the list of devices in Windows Explorer , check if the PC and the IFE server are not connected through the router.
5	Double-click the selected IFE-XXYYZZ, the login page automatically opens in the browser.
6	Enter <code>Administrator</code> as the user name and <code>Gateway</code> as the default password, the home page automatically opens in the browser. NOTE: The user name and password are case-sensitive. The <code>Administrator</code> user name cannot be changed as it is default user name for administrator role.
7	To change the default password, select the Configuration and settings menu, go to Other Configuration submenu, click User Accounts and enter new password for <code>Administrator</code> user name.
8	To locate the IFE-XXYYZZ, select the Configuration & Settings menu, go to General submenu, click Device Physical Location , and click Blink ON . The ULP LED of the selected IFE-XXYYZZ blinks for 15 seconds (test mode).
9	To name the IFE-XXYYZZ, select the Configuration & Settings menu, go to Device Configuration submenu, click Device List and then click Name . Click IFE-XXYYZZ to set the IFE name.
10	Write the IFE name on a blank device name label and stick it on the existing one.

NOTE:

- XXYYZZ is the last 3 bytes of the MAC address in hexadecimal format.
- Check the firewall settings if DPWS is not enabled.

First Access Through PC with Windows XP

Step	Action
1	Disconnect the PC from the local area network (LAN) and switch off Wi-Fi.
2	Connect an Ethernet cable from the PC to the IFE server.
3	Start the web browser (<i>see page 35</i>). NOTE: The PC automatically uses the default IP address 169.254.## (##=0–255) and the default subnet mask 255.255.0.0.
4	In the address text box, enter 169.254.YY.ZZ, where YY and ZZ are the last 2 bytes of the IFE server MAC address (to be found on the IFE server side label), then press Enter : the home page opens in the browser. Example: For an IFE with MAC address 00-B0-D0-86-BB-F7 or 0-176-208-134-187-247 in decimal, enter 169.254.187.247 in the address text box.
5	Press Enter , the login page automatically opens in the browser.
6	Enter <code>Administrator</code> as the user name and <code>Gateway</code> as the default password. The homepage automatically opens in the browser. NOTE: The user name and password are case-sensitive. The <code>Administrator</code> user name cannot be changed as it is default user name for administrator role.
7	To change the default password, select the Configuration and settings menu, go to Other Configuration submenu, click User Accounts and enter new password for <code>Administrator</code> user name.
8	To locate the -XXYYZZ, select the Configuration & Settings menu, go to General submenu, click Device Physical Location , go to Device Physical Location , and click Blink ON . The ULP LED of the selected -XXYYZZ blinks for 15 seconds.
9	To name the -XXYYZZ, select the Configuration & Settings menu, go to Device Configuration submenu, click Device List and then click Name to set the IFE name.
10	Write the IFE name on a blank device name label and stick it on the existing one.

NOTE: XXYYZZ is the last 3 bytes of the MAC address in hexadecimal format.

Access to Webpages

Follow the Network Discovery, Name Browsing, and IP Address Browsing process to access the webpages.

The webpage access depends on the IT infrastructure.

Network Discovery

Follow the below procedure to access the IFE webpages once the IFE name has been configured.

Step	Action
1	Connect the IFE server or the Ethernet switch inside the panel to the local area network (LAN).
2	Connect the PC to the local area network (LAN).
3	Open Windows Explorer .
4	Click Network , the IFE name is displayed in the list of devices. NOTE: If the IFE name is not displayed in the list of devices in Windows Explorer , check if the PC and the IFE server are not connected through the router.
5	Double-click the IFE name which is written on the device label located on the front face of the selected IFE server, the login page automatically opens in the browser.

Name Browsing

DNS server is mandatory.

Step	Action
1	Connect the IFE server or the Ethernet switch inside the panel to the local area network (LAN).
2	Connect the PC to the local area network (LAN).
3	Start the web browser (<i>see page 35</i>).
4	In the address text box, enter the IFE name which is written on the device label located on the front face of the selected IFE server.
5	Press Enter , the login page automatically opens in the browser. NOTE: If the IFE server does not appear in the list of devices in Windows Explorer , check if the PC and the IFE server are not connected through the router.

NOTE: The IFE IP address is mapped to the device label in the DNS server.

IP Address Browsing

IP static configuration has to be set.

Step	Action
1	Connect the IFE server or the Ethernet switch inside the panel to the local area network (LAN).
2	Connect the PC to the local area network (LAN).
3	Start the web browser (<i>see page 35</i>).
4	In the address text box, enter IP address given by the IT administrator.
5	Press Enter , the login page automatically opens in the browser. NOTE: If the login page in the web browser does not open or does not display correctly, check if Internet Explorer\Tools\Compatibility View Settings\Display Intranet sites in Compatibility View in Internet Explorer is checked.

User Interface Layout

Overview

This graphic shows the IFE user interface layout.

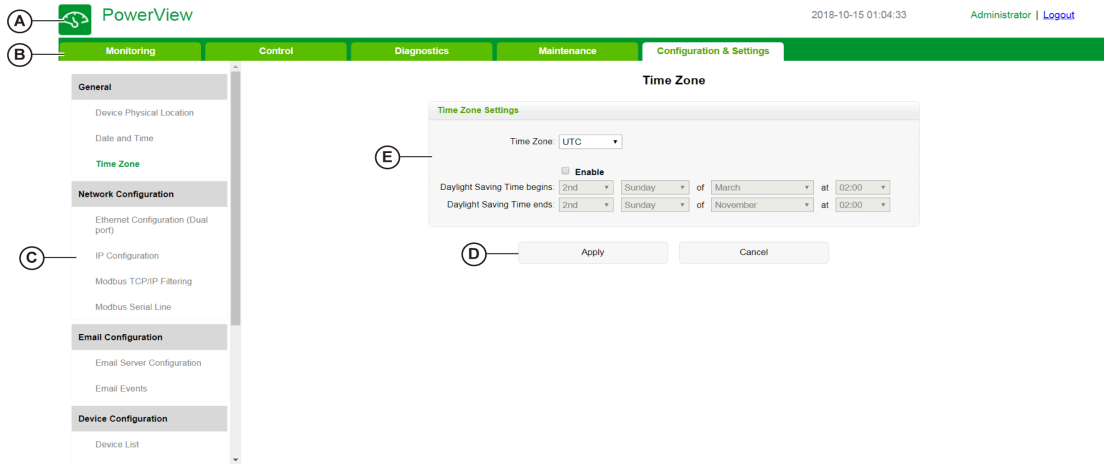

- A Banner
- B Menu tabs
- C Subtabs
- D Action button
- E Display zone

Banner

The banner displays the following information at the top of all the pages.

Generic Information	Description
Date and time	Current date and time in the format yyyy-mm-dd hh-mm-sec
User name checked	Name of the user who has logged in
Logout	To log out the IFE session, click Logout or close your browser. It is recommended to log out from the IFE session when it is not in use.

Main Tabs

The main tabs are:

- **Monitoring**
- **Control**
- **Diagnostics**
- **Maintenance**
- **Configuration & Settings**

Subtabs

The subtabs display the submenus under the selected main tab.

Action Buttons

The action buttons correspond to the selected tab and it varies.

The following table describes the interface buttons:

Button	Action
Apply	Applies the changes.
Cancel	Cancel the modifications to return to the last saved settings.

Display Zone

The display zone shows the selected subtab in detail with all the related fields.

Webpage Description

Monitoring Webpage

Monitoring Submenu	Webpage	Description
Real Time Data	Single Device Pages <i>(see page 74)</i>	The single device pages provide basic readings of the selected devices.
	Summary Device Pages <i>(see page 74)</i>	The summary device pages provide summaries of one or more selected devices.
	Trending <i>(see page 74)</i>	The trending page view provides real-time graphic and table trending of common topics across multiple devices.
Device Logging	Single Device Pages <i>(see page 76)</i>	The single device pages provide the graphic and table trending logs of user-selectable quantities for selected devices.
	Summary Device Pages <i>(see page 78)</i>	The summary device pages provide graphic trending logs of multiple devices with a common topic.

Control Webpage

Control Submenu	Webpage	Description
Device Control	Device Control <i>(see page 80)</i>	Resets and controls the connected slave devices.
Set Device Time	Set Device Time <i>(see page 83)</i>	Sets the slave device time to synchronize with the IFE time and displays the slave device time of the selected device.

Diagnostics Webpage

Diagnostics Submenu	Webpage	Description
General	Statistics <i>(see page 85)</i>	Displays diagnostic data used to troubleshoot the network-related problems.
Product Information	Device Identification <i>(see page 87)</i>	<ul style="list-style-type: none"> Displays the IFE basic information to set the IFE device name and helps in the device physical location. Contains information about the product name, serial number, model number, firmware version, unique identifier, MAC address, IPv4 address, and IPv6 link local address.
	IMU Information <i>(see page 88)</i>	Displays the list of the IMU devices connected to the ULP port.
Device Health Check	Read Device Registers <i>(see page 89)</i>	Displays register data connected locally to the IFE server.
	Communications Check <i>(see page 90)</i>	Verifies the communications health of all the slave devices connected to IFE server.
IO Readings	IO Readings <i>(see page 91)</i>	<p>Displays the status of IO module of the selected device. Displays No IO modules connected if the selected device is not connected to a IO module.</p> <p>NOTE: IO Module refers to the slave device name defined in the Device List page.</p>

Maintenance Webpage

Maintenance Submenu	Webpage	Description
Indicators	Indicators <i>(see page 93)</i>	Displays the maintenance counters of the connected ULP devices.

Configuration & Settings Webpage

Configuration & Settings Submenu	Webpage	Description
General	Device Physical Location <i>(see page 42)</i>	<ul style="list-style-type: none"> Locate the IFE-XXYYZZ server Click Blink ON. The ULP LED of the selected IFE-XXYYZZ server blinks and is active for 15 s (Test mode: 1 s ON, 1 s OFF).
	Date and Time <i>(see page 43)</i>	Sets the date and time manually or sets the IFE time automatically using an SNTP source or configures the slave device connected to IFE server to synchronize their time with the IFE time automatically.
	Time Zone <i>(see page 45)</i>	Configures the time zone for the region and sets the daylight saving time.
Network Configuration	Ethernet Configuration (Dual port) <i>(see page 46)</i>	Configures the Ethernet.
	IP Configuration <i>(see page 47)</i>	Configures the IP parameters.
	Modbus TCP/IP Filtering <i>(see page 49)</i>	Configures the maximum number of Modbus TCP/IP server connections. Configures the IP addresses that can access the IFE server through Modbus TCP/IP.
	Modbus Serial Line <i>(see page 50)</i>	Configures serial communication parameters.
Email Configuration	Email Server Configuration <i>(see page 51)</i>	Configures the alarms to be emailed. Configures the SMTP parameter for mailing purpose.
	Email Events <i>(see page 53)</i>	Configures the alarms to be sent through email.
Device Configuration	Device List <i>(see page 61)</i>	Configures local serial devices on the Modbus serial daisy chain and IMU core product connected to the ULP port of the IFE server.
	Device Logging <i>(see page 65)</i>	Configures device logging parameters.
	Device Log Export <i>(see page 67)</i>	Configures device logging export options.
Other Configuration	SNMP Parameters <i>(see page 68)</i>	Configures Simple Network Management Protocol (SNMP).
	Preferences <i>(see page 69)</i>	Configures IFE preferences.
	Advanced Services Control <i>(see page 70)</i>	Configures the advanced service control parameters.
	User Account <i>(see page 71)</i>	Creates and edits groups and users. Configures email accounts.
	Webpage Access <i>(see page 72)</i>	Configures webpage access rights for each user group.

Section 2.2

Configuration & Settings Webpages

What Is in This Section?

This section contains the following topics:

Topic	Page
General	42
Date and Time	43
Time Zone	45
Ethernet Configuration (Dual Port)	46
IP Configuration	47
Modbus TCP/IP Filtering	49
Modbus Serial Line	50
Email Server Configuration	51
Email Events	53
Device List	61
Device Logging	65
Device Log Export	67
SNMP Parameters	68
Preferences	69
Advanced Services Control	70
User Accounts	71
Webpage Access	72

General

Device Physical Location

Step	Action	Result
1	From the IFE menu bar, click Configuration & Settings .	Opens the Configuration & Settings menu.
2	From the Configuration & Settings menu, in the General submenu, click Device Physical Location .	Opens the Device Physical Location page.
3	In Device Physical Location webpage, click Blink ON .	Sets the IFE server in test mode and the LED blinks in ULP pattern with 1 second ON and 1 second OFF.

Date and Time

Description

The **Date and Time** page allows you:

- To manually set the date and time of the circuit breaker connected to the IFE interface
- To automatically synchronize the date and time of the circuit breaker to the IFE time
- To periodically check the synchronization at specified interval of time

List of Parameters in Date and Time Configuration

Parameter	Description
Manual	Allows you to select the manual date and time setting of slave devices. This option is disabled when Automatic (SNTP) is selected.
Date	Allows you to set the present date manually in the format YYYY-MM-DD.
Time	Allows you to set the present time manually in the format hh:mm:ss.
Automatic (SNTP)	Allows you to select an external time server (SNTP server) for IFE server and synchronize the time of its slave devices automatically.
Poll Interval	Allows you to enter the poll interval in hours that ranges from 1 through 63.
Obtain Servers Automatically via DHCP/BOOTP	Allows you to enable the check box that obtains the server address from DHCP or BOOTP.
Primary SNTP/NTP server	Allows you to enter the primary SNTP server address.
Secondary SNTP/NTP server	Allows you to enter the secondary SNTP server address.
Apply	Allows you to automatically synchronize the selected device with the IFE time.
Cancel	Allows you to clear the synchronization of the selected device.

Setting the IFE Date and Time Manually

Step	Action	Result
1	From the IFE menu bar, click Configuration & Settings .	Opens the Configuration & Settings menu.
2	In the General submenu, click Date and Time and then select Manual from the Date/Time Settings .	The parameters for date and time settings is available.
3	Enter the date in the format YYYY-MM-DD.	Sets the date of the IFE server manually.
4	Enter the time in the format hh:mm:ss.	Sets the time of the IFE server manually.
5	Click Apply .	The date and time of IFE server is set.

Setting the IFE Date and Time Automatically with SNTP

Step	Action	Result
1	From the IFE menu bar, click Configuration & Settings .	Opens the Configuration & Settings menu.
2	In the General submenu, click Date and Time and then select Automatic (SNTP) from the Date/Time Settings .	The slave devices of IFE server are selected by default for date and time synchronization.
3	Enter the poll time in the Poll Interval box.	The entered time is updated.
4	Select to obtain SNTP server automatically via DHCP/BOOTP.	The SNTP server address is obtained automatically.
5	Enter the primary and secondary server address in the Primary SNTP/NTP server and Secondary SNTP/NTP server box.	The entered SNTP server address is updated.
8	Click Apply .	The date and time of the selected slave devices get synchronized with the IFE time.

Setting the Date and Time of Slave Devices

Follow this procedure to set the date and time of slave devices of IFE server.

Step	Action	Result
1	From the IFE menu bar, click Configuration & Settings .	Opens the Configuration & Settings menu.
2	In the General submenu, click Date and Time .	The selection of slave devices and Every box is available.
2	In Date and Time: Periodic Spreading , select the Every check box and enter the time interval.	Allows you to enter the time interval in hours.
3	Select the slave devices from the device list which supports date and time setting from external source.	The slave devices get selected.
8	Click Apply .	The date and time of the selected slave devices get synchronized with the IFE time immediately and also periodically as per the selected time interval.

Time Zone

Time Zone Configuration

Step	Action
1	From the IFE menu bar, click Configuration & Settings .
2	From the Configuration & Settings menu, in the General submenu, click Time Zone .
3	In Time Zone Configuration webpage, select the time zone of your region from the Time Zone list.
4	Select the Enable check box if you have to set the daylight saving time.
5	Select the beginning and end time of daylight saving from the Daylight Saving Time begins and the Daylight Saving Time ends list.
6	Click Apply to save the settings.

NOTE: The settings of **Time Zone** is applicable only when **Date and Time** is in **Automatic** mode.

Real Time Clock

The IFE server has a real time clock (RTC) to maintain date and time during power outage. The expected life time of the RTC is 15 years when operated at intermediate mode (in this mode, the battery is operated continuously for 4 days with an interval of 45 times over a period of 10 years).

The IFE server must maintain a crystal tolerance of ± 20 ppm (typical)/ ± 150 ppm (maximum) during the period of 15 years at -25 °C (-13 °F) to 85 °C (185 °F). The time drift by RTC chip varies from -16 s/day to $+2$ s/day. During power recycle, the RTC is able to maintain the date and time settings.

Ethernet Configuration (Dual Port)

Ethernet

Parameter	Description	Settings
MAC address	A unique media access control address of an IFE server. The MAC address is written on the label which is placed on the side of the IFE server.	–
Frame format	Used to select the format for data sent over an Ethernet connection. NOTE: Whenever the frame format settings are changed, restart the device to implement the changes.	<ul style="list-style-type: none"> ● Ethernet II ● 802.3 ● Auto (Factory setting)

Ethernet Port Control

Parameter	Description	Settings
Speed and mode for Port #1	Used to define the physical Ethernet connection speed and transmission mode for Ethernet port 1.	Auto-negotiation (Factory setting)
Speed and mode for Port #2	Used to define the physical Ethernet connection speed and transmission for Ethernet port 2.	Auto-negotiation (Factory setting)

Broadcast Storm Protection

Parameter	Description	Settings
Level	Defines the storm protection level. The level value corresponds to a committed information rate (CIR) value, that is, the amount of traffic entering the switch port from which the storm protection drops entering the broadcast traffic. NOTE: If the level value is changed, you are prompted to restart the device to implement changes.	<ul style="list-style-type: none"> ● 0 ● 1 ● 2 ● 3 ● 4 (Factory setting) ● 5 ● 6
Committed Information Rate	Defines the read-only value of the storm protection level.	–

IP Configuration

IPv4 Configuration

Parameter	Description	Settings
Obtain an IP address automatically using	Used to select the mode for assigning the IPv4 parameters set. Obtain IPv4 parameters automatically using BOOTP or DHCP. NOTE: While using a legacy DHCP server, the device name must be limited to 16 characters.	<ul style="list-style-type: none"> ● DHCP (Factory setting) ● BOOTP
Manual IP address	Used to enter the static IP address of an IFE server.	–
Manual Subnet mask	Used to enter the Ethernet IP subnet mask address of your network.	–
Manual Default gateway	Used to enter the gateway (router) IP address used for wide area network (WAN) communication.	–

IPv6 Configuration

Parameter	Description	Settings
Enable IPv6	Defines the IPv6 configuration.	Enabled (Factory setting) NOTE: The setting is unavailable to edit.
Link local address	Used to open the IFE webpage for future use. NOTE: In the URL address box, use [] brackets to enter the link local address.	–

DNS

Parameter	Description	Setting
Obtain DNS address automatically	Defines the dynamic behavior of the DNS server address configuration. Used to obtain the IP address from the DNS server automatically. NOTE: Domain name system (DNS) is the naming system for computers and devices connected to a local area network (LAN) or the Internet.	Disabled when manual setting is selected.
Manual Primary server address	Defines the IPv4 address of the primary DNS server.	–
Manual Secondary server address	Defines the IPv4 address of the secondary DNS server. Used to perform a DNS resolution when the resolution fails with the primary DNS server.	–

Duplicate IP Address Detection

While connected to your network, the IFE server publishes its IP address. To avoid any duplicate IP address conflicts, the IFE server uses the address resolution protocol (ARP) to see if any other device on your network is using the same IP address. The following table explains how the IFE server handles a duplicate IP address when it is detected.

Duplicate IP Address Scenario

Scenario	Duplicate IP Detected	Network Status LED
Ethernet link detected	Reverts to the default IP address, subnet mask, and gateway address. ARP requests are sent every 15 seconds until the IP address is available. IFE server uses the IP address when it is available,	Steady red
Manual address change	Reverts to the default IP address, subnet mask, and gateway address. The ARP requests are sent every 15 seconds until the IP address is available. The IFE server uses the IP address when it is available.	Steady red
Receives an ARP request	If more than one ARP is detected within 10 seconds, initiate the process to reacquire the IP.	OFF

Modbus TCP/IP Filtering

Description

The **Modbus TCP/IP Filtering** page allows you to define the level of access for Modbus TCP/IP clients connected to IFE server.

Block Connections

You can select the maximum number of IP connections allowed, 8 or 16. Each connection can have 12 concurrent transactions simultaneously.

NOTE: When the maximum number of IP connections is changed, a message pops-up on the screen **Max Connection is changed. Restart the Device to Take Effect** and prompts to restart the device.

If IP Filtering is enabled, you must configure the IP address of the PC in the list of allowed addresses with read/write permission for using the EcoStruxure Power Commission software.

IP Filtering

Parameter	Description	Setting
Enable IP Filtering	Activates the IP address filtering. The list of IP addresses available in the table is granted access.	<ul style="list-style-type: none"> ● Enabled ● Disabled (No filtering)
IP Address	Filters the required IP address entered by you.	10 addresses (Maximum allowed IP addresses)
Access level	Defines the access level for the corresponding IP address.	<ul style="list-style-type: none"> ● Read: The following Modbus TCP/IP function codes are allowed: <ul style="list-style-type: none"> ○ 1 (0x01) ○ 2 (0x02) ○ 3 (0x03) ○ 4 (0x04) ○ 7 (0x07) ○ 8 (0x08) ○ 11 (0x0B) ○ 12 (0x0C) ○ 17 (0x11) ○ 20 (0x14) ○ 24 (0x18) ○ 43 (0x2B), with subfunction codes 14 (0x0E), 15 (0x0F), and 16 (0x10). ○ 100 (0x64) ● None: The access to the IP address is blocked. ● Read/Write: Full access is provided.
Allow Anonymous IP	Allows all Modbus TCP/IP clients to have the read-only access.	<ul style="list-style-type: none"> ● Enabled ● Disabled (Factory setting)

Modbus Serial Line

Modbus Serial Line Settings

Parameter	Settings
Baud Rate	<ul style="list-style-type: none">● 9600 bps● 19200 bps (Factory setting)● 38400 bps
Parity	<ul style="list-style-type: none">● Even (Factory setting)● Odd● None
Nb bits of Stop	<ul style="list-style-type: none">● Auto (Factory setting)● 1 bit● 2 bits
Serial line termination	<ul style="list-style-type: none">● Enabled (Factory setting)● Disabled
Modbus SL timeout	<ul style="list-style-type: none">● 1 s (Factory setting)● 0.1–0.5 s● 1–10 s

NOTE: When **Nb bits of Stop** parameter is set to **Auto**, the actual value is based on the parity chosen.

Email Server Configuration

Introduction

The built-in email alarm notifications are sent through emails when the connected devices trigger an alarm. The alarms are notifications that occur in response to a status change or when a value exceeds a threshold value. The administrator selects and configures several alarm notifications. The recipient list is configurable to notify the several users of the same alarm.

The email alarm notifications require unfiltered Internet access. This level of service is suited for small or mid-sized non-critical buildings. The device sends the emails when Internet access is available through a dedicated connection or through a local area network (LAN) with Internet access.

NOTE: The email alarm notifications should not be used if email services are managed internally by a customer IT domain administrator.

Email Service

Parameter	Description	Setting
My Own SMTP Server	Sets My Own SMTP Server profile as the email service in IFE server by default. If you have configured SMTP profile for the previous version of the IFE server, on updating to a newer version, you can still retrieve the saved configuration under My Own SMTP Server profile.	–

Email SMTP Server Settings

Parameter	Description	Setting
SMTP server address	Allows you to enter an email server address (SMTP server). NOTE: Contact your network administrator to know the IP address or the name of the simple mail transfer protocol (SMTP) server.	–
SMTP server port	Allows you to enter the SMTP server port.	<ul style="list-style-type: none"> ● 25 ● 587 (factory setting) ● 2525
Authentication	If the SMTP server requires login information, enable the Authentication Enable check box.	<ul style="list-style-type: none"> ● Enabled ● Disabled (factory setting)
SMTP account login	Allows you to enter the SMTP account login name.	–
SMTP account password	Allows you to enter the SMTP account password.	–

Email Sender Address

Parameter	Description	Setting
From address	In the From Address box, enter the email address of the administrator.	–

The **From address** can be used in different ways:

- Use the **From address** as a context provider: If you do not want to receive any reply, and only notify the recipient, use **From address** as contextual information. The **From address** syntax includes “no-reply”, “device name”, “site name”, @a validated domain .com, .net, and so on.
- Create an alias in the **From address** to allow replies to be sent to the person in charge of an alarm: An email can be sent to multiple people who are responsible for a specific appliance. This feature allows the receivers to reply to follow up with the responsible person.
For example, the facility manager would receive an email from an alarm. Facility manager can send a reply email to the maintenance contractor to follow up on the action.

Email Language

Parameter	Description	Setting
Language	Allows you to select the language of the email body.	<ul style="list-style-type: none">• English (factory setting)• French

Email Test

Parameter	Description	Setting
Recipient address for test	Allows you to enter the email address of the recipient to test the delivery of the email.	–

The **Email Test** feature enables connection from the device to the service. If the test emails are not received, the Internet connection needs to enable the email ports (port 25 or 587 or 2525). The required setting of the port is done in accordance between the device that sends the email and the site router settings.

NOTE: The email with custom text that uses characters such as à, è, ù, é, â, ê, î, ô, ú, ë, ï, ü, ÿ, and ç are not shown correctly in the email. However, the generic text message is shown correctly.

Email Events

Description

The **Email Events** page allows the selection of the events to notify through email among a list of events.

⚠ CAUTION
EQUIPMENT INCOMPATIBILITY OR INOPERABLE EQUIPMENT
Do not rely solely on the notification of the emails for maintaining your equipment. Failure to follow these instructions can result in injury or equipment damage.

The list of event displayed contains only applicable events related to the devices connected to the ULP port of the IFE server.

NOTE: If an email SMTP server is not located on the same Ethernet network segment as IFE server, ensure that the IFE default gateway is properly configured.

Parameter	Description
Events	List of events for configuration
Add Event	A check box to enable to add events.
Email Recipients	Allows you to choose from a list of email recipients. NOTE: You can choose a maximum of 12 recipients.
Custom Text	Allows you to enter a custom text. NOTE: You can enter a maximum of 63 characters in the custom text area.

Events from ComPact NSX, ComPact NS, or MasterPact NT/NW Circuit Breakers

Device Connected	Events
ComPact NSX circuit breaker with BSCM module	Circuit breaker indicator status (OF)
	Fault trip indicator status (SDE)
	Trip indicator status (SD)
ComPact NSX circuit breaker with MicroLogic trip unit or ComPact NS, or MasterPact NT/NW circuit breaker with BCM ULP module	Long time protection Ir pre-alarm (PAL Ir)
	Long time protection Ir
	Short time protection Isd
	Instantaneous protection li
	Ground fault protection Ig
	Earth leakage (Vigi) protection IΔn
	Integrated Instantaneous protection
	STOP (trip unit internal failure)
	Instantaneous with earth leakage protection
	Reflex tripping protection
	Unbalance motor protection
	Jam motor protection
	Underload motor protection
Long start motor protection	

Device Connected	Events
ComPact NS, or MasterPact NT/NW circuit breaker with BCM ULP module	Iunbal protection
	I1 Max protection
	I2 Max protection
	I3 Max protection
	IN Max protection
	Vmin protection
	Vmax protection
	Vunbal protection
	Reverse power protection
	Fmin protection
	Fmax protection
	Phase rotation
	Ready to close status (PF)
	Wear on contacts
	Arc reduction state engaged
ComPact NSX circuit breaker with MicroLogic trip unit	User-defined alarm 1
	User-defined alarm 2
	User-defined alarm 3
	User-defined alarm 4
	User-defined alarm 5
	User-defined alarm 6
	User-defined alarm 7
	User-defined alarm 8
	User-defined alarm 9
	User-defined alarm 10

Events from MasterPact MTZ Circuit Breaker

Device Connected	Events
MasterPact MTZ circuit breaker with MicroLogic X control unit	I _r trip
	I _{sd} trip
	I _i trip
	I _g trip
	I Δ _n trip
	Ultimate self-protection trip (SELLIM)
	Self diagnostic trip
	Ultimate self-protection trip (DIN/DINF)
	I Δ _n /I _g test trip
	Undervoltage on 1 phase trip
	Overvoltage on 1 phase trip
	Reverse power trip
	Undervoltage on all 3 phases trip
	Overvoltage on all 3 phases trip
	Optional protection trip
	Ultimate self-protection (DIN/DINF) operate
	Ultimate self-protection (SELLIM) operate
	Thermal memory reset order

Device Connected	Events
MasterPact MTZ circuit breaker with MicroLogic X control unit	Ir prealarm (I > 90% Ir)
	Ir start (I > 105% Ir)
	Ir operate
	Isd start
	Isd operate
	Ii operate
	Ig alarm
	Ig start
	Ig operate
	IΔn alarm
	IΔn start
	IΔn operate
	Undervoltage on 1 phase start
	Undervoltage on 1 phase operate
	Undervoltage on all 3 phases start
	Undervoltage on all 3 phases operate
	Overvoltage on 1 phase start
	Overvoltage on 1 phase operate
	Overvoltage on all 3 phases start
	Overvoltage on all 3 phases operate
	Reverse Power start
	Reverse Power operate
	ERMS engaged
	ERMS engaged for more than 24 hours
	ESM (ERMS switch module) self diagnostic alarm
	Communication lost with ESM (ERMS switch module)
	Request to unlock ERMS by Smartphone
	B curve active
	Optional protections inhibited by IO
	Circuit breaker opened
	Circuit breaker closed
	Closing order sent to XF
	Opening order sent to MX
	Circuit Breaker did not open or close

Device Connected	Events
MasterPact MTZ circuit breaker with MicroLogic X control unit	Manual mode enabled
	Local mode enabled
	Allow control by Digital input is disabled (by EcoStruxure Power Commission)
	Closing inhibited by communication
	Closing inhibited through IO module
	Alarm reset
	M2C output 1 is forced
	M2C output 2 is forced
	Protection settings change by display enabled
	Remote protection settings change enabled
	Protection settings changed by display
	Protection settings changed by Bluetooth/USB/IFE
	Communication lost with IO#1 module
	Communication lost with IO#2 module
	Config error IO/CU: dual settings or inhibit cls.
	Config error IO/CU: optional protection Inhibit
	Config. error IO and CU - Local/Remote mode
	Date and time set
	Digital module license installed
	Digital module license uninstalled
	Digital module license expired
	Digital module license rejected
	Digital module License expires in 30 days
	Digital module License expires in 20 days
	Digital module License expires in 10 days
	Connection on USB port
	Injection test in progress
	Ig function inhibited for test propose
	Test aborted by user
	Ig protection in OFF mode
	Control unit self test major malfunction 1
	Control unit self test major malfunction 2
	Control unit self test major malfunction 3
	Control unit self test major malfunction 4

Device Connected	Events
MasterPact MTZ circuit breaker with MicroLogic X control unit	Control unit self test major malfunction 5
	Internal current sensor disconnected
	External neutral current sensor disconnected
	Earth leakage (Vigi) sensor disconnected
	Protection settings reset to factory values
	Protection settings no accessible # 1
	Protection settings no accessible # 2
	Protection settings no accessible # 3
	Protection settings no accessible # 4
	Protection settings no accessible # 5
	Control unit self test # 1
	Control unit self test # 2
	Control unit self test # 3
	Control unit self test # 4
	Control unit self test # 5
	Invalid measurement and optional protection # 1
	Invalid measurement and optional protection # 2
	Invalid measurement and optional protection # 3
	Invalid optional protection self test
	NFC invalid communication #1
	NFC invalid communication #2
	NFC invalid communication #3
	Invalid display screen or wireless communication # 1
	Invalid display screen or wireless communication # 2
	Invalid display screen or wireless communication # 3
	Loss of IEEE 802.15.4 communication
	Loss of Bluetooth communication
	Replace Battery
	No battery detected
	Control Unit alarm reset
	Self diagnostic test - firmware
	Unable to read sensor plug
	Invalid Control Unit factory config #1
Invalid Control Unit factory config #2	

Device Connected	Events
MasterPact MTZ circuit breaker with MicroLogic X control unit	Critical hardware modules discrepancy
	Critical firmware modules discrepancy
	Non-critical hardware modules discrepancy
	Non-critical firmware modules discrepancy
	Firmware discrepancy within control unit
	IΔn/Ig test - no trip
	IΔn/Ig test button pressed
	ZSI test in progress
	Contact wear is above 60% Check contacts
	Contact wear is above 95% Plan for replacement
	Contacts 100% worn out CB needs to be replaced
	Less than 20% CB operation remaining
	CB has reached the max number of operations
	Invalid self test - MX1 shunt trip
	MX1 shunt trip not detected
	MCH charging operations above threshold
	MCH has reached the max number of operations
	Invalid self test - XF shunt close
	XF shunt close not detected
	Invalid self test - MN undervoltage release
	MN undervoltage release not detected
	Voltage loss on MN undervoltage release
	Communication loss on MN undervoltage release
	Invalid self test - MX2 shunt trip
	MX2 shunt trip not detected
	Presence of external 24V power supply
	Loss of voltage and CB is closed
	Events in history log have been erased
	Reset Min/Max currents
	Reset Min/Max voltages
	Reset Min/Max power
	Reset Min/Max frequency
	Reset Min/Max harmonics
Reset Min/Max power factor	

Device Connected	Events
MasterPact MTZ circuit breaker with MicroLogic X control unit	Reset current demand
	Reset power demand
	Reset energy counters
	Bluetooth communication enabled
	ZigBee communication enabled
	Connection on Bluetooth port
	Underfrequency trip
	Overfrequency trip
	Underfrequency start
	Overfrequency start
	Underfrequency operate
	Overfrequency operate
	Diagnostic data (link)
	Last event sequence number
	voltage release operation counter is above alarm threshold
	voltage release has reached the max number of operations
	MX2 voltage release operation counter above alarm threshold
	MX2 voltage release reached the max number of operations
	MX1 voltage release operation counter above alarm threshold
	MX1 voltage release reached the max number of operations
	MN undervoltage release operation counter is above alarm threshold
	MN undervoltage voltage release reached the max number of operations
	Schedule basic maintenance within one month
	Schedule standard maintenance within one month
	Schedule manufacturer maintenance within three months
	After 6 months of commissioning protection settings still set to factory default
	Remaining service life of MicroLogic below alarm threshold
	MicroLogic control unit reached the max service life
	Last modification of protection settings not completely applied
	Frequency based protection

Events from IO Modules

Device Connected	Events
IO module 1	Threshold overrun on Input 1 counter (#1)
	Threshold overrun on Input 2 counter (#1)
	Threshold overrun on Input 3 counter (#1)
	Threshold overrun on Input 4 counter (#1)
	Threshold overrun on Input 5 counter (#1)
	Threshold overrun on Input 6 counter (#1)
	Switchboard Temperature threshold 1(#1)
	Switchboard Temperature threshold 2 (#1)
	Switchboard Temperature threshold 3 (#1)
	IO module Failure (STOP mode) (#1)
	IO module Failure (ERROR mode) (#1)
	IO module 2
Threshold overrun on Input 2 counter (#2)	
Threshold overrun on Input 3 counter (#2)	
Threshold overrun on Input 4 counter (#2)	
Threshold overrun on Input 5 counter (#2)	
Threshold overrun on Input 6 counter (#2)	
Switchboard Temperature threshold 1(#2)	
Switchboard Temperature threshold 2 (#2)	
Switchboard Temperature threshold 3 (#2)	
IO module Failure (STOP mode) (#2)	
IO module Failure (ERROR mode) (#2)	
IO module 1 or IO module 2	
	Cradle has reached its maximum number of operations
	Remaining service life of cradle is below alarm threshold
	New MicroLogic unit has been detected
	Discrepancy with ERMS orders
	Earth leakage trip signal contact (SDV) alarm
	Control voltage presence contact alarm
	Surge protection status contact alarm
	Surge failure contact alarm
	Switch disconnecter ON/OFF indication alarm contact (OF)
	Fuse blown indication contact alarm
	Emergency Stop alarm
	Switchboard temperature contact alarm
	Switchboard ventilation contact alarm
	Switchboard door contact alarm
	Cradle connected position status (CE)
	Cradle disconnected position status (CD)
Cradle test position status (CT)	

Device List

Description

The **Device List** page is used to define the list of devices connected to the IFE server (ULP port, serial port) and remote Modbus/TCP slave devices. In the device list, you can add, delete and/or discover devices.

The list of connected devices is defined by either of the following:

- Automatically, by using the device discovery procedure
- Manually, by adding the devices one by one.

NOTE: The webpages are supported only for the devices added in the device list.

Number of Modbus Slave Devices

A maximum of 20 slave devices can be added in the device list. Under each IFE server or master remote device, a maximum of 11 IFM interfaces can be added.

The application dictates the maximum slave devices or IFM interfaces that can be used. The following general guidelines can be used to size the application:

- Maximum of 20 slave devices are technically supported via the IFE webpages.
- Maximum of 11 IFM interfaces can be physically connected to one IFE server. This can be used for applications that have the lowest performance requirement and are recommended for simple applications.
- Maximum of 8 IFM interfaces should be used for applications that requires regular access via the IFE webpages or that have other masters communicating, such as FDM128 display. This normally provides a reasonable response time for up to three masters.
- The number of IFM interfaces that can be stacked in a more complex environment, for example, with SCADA or Building Management Systems must be scaled to the performance needs in the application.

Device List Parameters

Parameters	Description	Settings
IP Address	Displays the device IP address. <ul style="list-style-type: none"> • For IFE server: The IP Address box is unavailable to edit. • For remote device: Allows you to enter IP address in the IP Address box. 	–
Gateway	Indicates if the IP device is a gateway or not. <ul style="list-style-type: none"> • For IFE server: The Gateway check box is always selected. • For remote device: Allows you to add/discover the slave devices of remote device when you select the Gateway check box. 	Gateway check box is always selected.
Address	Displays the Modbus slave address of the IFE server and the remote device. <ul style="list-style-type: none"> • For IFE server: The Address box is unavailable to edit. • For remote device: Allows you to enter the Modbus slave address of the remote device in the Address box. 	<ul style="list-style-type: none"> • For IFE server: 255 (fixed) • For remote device: (1–247 or 255)
Name	Allows you to enter the names for IFE server and remote device. <p>NOTE:</p> <ul style="list-style-type: none"> • The LV breaker system is uniquely identified over possible interfaces such as HMI, Modbus/TCP, DPWS, and DHCP. • IFE device name is common across all interfaces. Thus, changing IFE device name by any means has direct impact on all the connected interfaces. 	The IFE name can have up to 64 ASCII characters with the following characters: A–Z , a–z , 0–9 , and - . However, - cannot be used at the end of the name. <p>NOTE:</p> <ul style="list-style-type: none"> • IFE name should be unique within the device list. • Duplicate IFE names for different devices may have impact on web applications, logging, and export features.
Connection	Displays the connection type. It is unavailable to edit.	The 2 types of port are: <ul style="list-style-type: none"> • ULP port • Serial port
Device Type	Allows you to select the slave devices from the list of supported devices (<i>see page 97</i>).	–

Parameters	Description	Settings
Device Name	<p>Allows you to enter the name for the discovered devices.</p> <ul style="list-style-type: none"> For ULP port: Click edit, and then click Device Name to edit the device name, For Serial port, remote device, and its slaves: Click Device Name to edit the device name. <p>NOTE: Delete and edit operations are not allowed if the device is selected for logging.</p>	<p>The device name can have up to:</p> <ul style="list-style-type: none"> 59 ASCII characters for MasterPact MTZ devices 64 ASCII characters for other devices <p>The allowed characters are: A-Z, a-z, 0-9, and -. However, - cannot be used at the end of the name.</p>
Slave ID	<p>Displays the local address of the device connected to the IFE server or remote device.</p>	<ul style="list-style-type: none"> For ULP port: 255 (Fixed) For Serial port and remote device: 1–247
Add Remote Devices	<p>Allows you to add remote devices. Using this feature, you can also add PowerTag energy sensors in the Device List. These PowerTag energy sensors are preconfigured with Acti9 Smartlink SI B or Acti9 Smartlink SI D device. For more information, refer to <i>Acti9 Smartlink SI B User Manual</i> or <i>Acti9 Smartlink SI D User Manual</i> accordingly.</p>	–
Apply	<p>Allows you to save device list configuration.</p>	–
Delete	<p>Allows you to delete the selected slave devices.</p> <p>NOTE: Delete operation is not allowed if the device is selected for logging.</p>	–
Discover	<p>Allows you to discover the slave devices.</p> <p>NOTE: The Discover button for the remote device is available only if you click the Apply button.</p> <p>NOTE: The discover option for the device type BCM-OF/SD is available only on IFE’s own IMU.</p>	–
	<p>Allows you to add a new slave device to the device list.</p>	–
Delete Remote Device	<p>Allows you to delete the remote device.</p> <p>NOTE: Delete operation is not allowed if the device is selected for logging.</p>	–

Adding Device to the Device List for the First Time

Step	Action	Result
1	<p>Slave device to IFE server: Add the slave devices to the IFE server manually (<i>see page 64</i>) or by device discovery (<i>see page 63</i>).</p>	Adds the slave device to IFE server.
2	<p>Remote device: In the Device List page, click Add Remote Devices to add a remote device.</p>	Adds the remote device in the Device List page.
3	<p>Slave device to remote device: Add the slave device for remote device by device discovery.</p> <p>NOTE: The Discover button for the remote device is available only if you click the Apply button.</p>	Adds the slave device to remote device.
4	<p>Repeat step 2 and 3 to add more remote devices to Device List page. Click Apply to save the modified changes.</p>	–

Device Discovery Procedure

When you start device discovery, the IFE server queries the ULP port, serial port, and Ethernet port using a user-defined address range. Modbus RTU protocol is used for discovery on the serial port. If the device replies to the query, the local ID is set to the current discovery address, and the device is given a default device name. The IFE server, then tries to identify the device type. If the IFE server recognizes the device type of the discovered device, the IFE server sets the recognized device type in the **Device Type** field. If the IFE server does not recognize the **Device Type** of the discovered device, the IFE server sets to Modbus in the **Device Type** field.

The list of devices supported by the IFE server is in Appendix (*see page 97*).

The table shows the steps to add device using device discovery procedure:

Step	Action	Result
1	From the IFE menu bar, click Configuration & Settings .	Opens the Configuration & Settings menu.
2	From the Configuration & Settings menu, in the Device Configuration submenu, click Device List .	Opens the Device List page.
3	To discover locally connected devices, click Discover .	Opens the Device Discovery page.
4	Enter Start Modbus ID and Stop Modbus ID .	Enters the discovery address range.
5	Select Discover Wireless Devices . NOTE: This option is available if the selected remote device is Acti9 Smartlink SI B or Acti9 Smartlink SI D and the device is selected by default.	<ul style="list-style-type: none"> ● If Discover Wireless Devices option is selected, the PowerTag energy sensors with Modbus slave ID range 150...169 is searched in addition to the slave devices given in the Start Modbus ID and Stop Modbus ID. ● If the Start Modbus ID and Stop Modbus ID range overlaps with PowerTag energy sensor Modbus ID range (150...169), then Discover Wireless Devices option is ignored during discovery. Only the devices in the given range of the Start Modbus ID and Stop Modbus ID is searched. ● If the selected remote device is Acti9 Smartlink SI D, then the Start Modbus ID and Stop Modbus ID is preset with values 150 and 169 respectively and is disabled. The Discover Wireless Devices option is selected and disabled.
6	Click Start Discover . (Click Stop Discover to stop the process). NOTE: Discovery only finds local serial Modbus devices connected to the IFE server. The device on the ULP port is discovered automatically.	Begins to discover all connected devices.
7	Enter a new device name in the Name text box.	Renames the device.
8	Select the Save check box for the device to be saved in the device list.	Selects or deselects a device entry to be saved or removed.
9	Click Apply in the Device Discovery page.	Displays the saved device list.

Device Discovery Parameters

Parameters	Description	Setting
Start/Stop Modbus ID	Defines the Modbus slave address range that is to be used to discover devices on the IFE serial port.	<ul style="list-style-type: none"> ● Start Modbus ID: 1–247 (Factory setting: 1) ● Stop Modbus ID: 1–247 (Factory setting: 10)
Save	Allows you to save the selected device to the Device List .	–
IP Address	Displays the IP address of the IFE server or the remote device.	–
Defined	Lists the device type that was defined for this device.	–
Assigned	Allows you to assign the device type from the drop-down list.	–
Name	Allows you to enter a custom name for the device.	–
Local ID	The slave address of the device connected to the IFE server.	–
Status	Displays the discovery or validation status.	<ul style="list-style-type: none"> ● Attempting (trying to determine the device type that matches in the device list.) ● Discovering (query attempt of device which is not in the device list.) ● Found (device found but the device type does not match what is defined in the device list.) ● Unknown (device found but the device type is unknown.) ● Valid (device type identified and matches what is defined in the device list.) ● Failed (failed to communicate with the device.)

Adding a Device Manually

Step	Action	Result
1	From the IFE menu bar, click Configuration & Settings .	Opens the Configuration & Settings menu.
2	From the Configuration & Settings menu, in the Device Configuration submenu, click Device List .	Opens the Device List page.
3	Click the  button to add a new device.	Allows you to add device in the device list.
4	Choose the supported device from the Device Type list.	Selects the device type selected from the list.
5	Enter a new device name in the Device Name text box.	Renames the device.
6	Enter the local address of the device in the Local ID text box.	Displays the local address of the device.
7	Click Apply .	A new device is added to the list.

Device Logging

Description

Logging is available for the devices which are in the device list (*see page 61*). The logging contents can be customized using topics. Topics are the parameters for a device that can be selected to have the desired logging content. The number of log entries per device is fixed irrespective to the number of topics selected for that device. The IFE server can log data received at predefined intervals (5, 10, 15, 20, 30, and 60 minutes). Below is an explanation of how the IFE server logs data and how to set up logging for a device.

NOTE: Device information in the **Device List** page cannot be edited if the device logging for that device is selected.

Logging Interval

Many devices in a power monitoring system do not have the ability to record data in non-volatile memory. The IFE server provides this data logging at predefined intervals for up to 13 devices.

The features of IFE data logging are:

- The maximum number of log entries per device is fixed to 12960.
- Select maximum of 13 devices for data logging.
- Select maximum of 24 topics per device for data logging (topics are kVAh, kWh, kVARh, and so on).
- Select the desired device and list of topics for data logging.

NOTE: Number of days of logging is impacted only by the log interval selected. It is independent of number of devices selected, number of topics selected per device, and type of topic selected.

Logging interval is a predefined time for the IFE server to log data received from the device. The logging capacity of a device is calculated by multiplying the log capacity factor with the logging interval set in the **Device Logging** page.

Logging capacity (in days) = Log capacity factor * logging interval (in minutes)

The log capacity factor is 9 and is calculated as follows:

Log capacity factor = 12960/1440

Where:

- 12960 is the maximum number of log entries per device
- 1440 is the number of minutes per day

Example: If the **Logging Interval** in the **Device Logging** page is set to 5 minutes, then the logging capacity is 45 days.

The table shows the logging capacity for the corresponding logging interval:

Logging Interval (Minutes)	Logging Capacity (Days)
5	45
10	90
15	135
20	180
30	270
60	540

Interval Logging Setting Procedure

Each device (except Acti9 Smartlink Ethernet and Acti9 Smartlink Modbus) in the device list may be independently enabled for logging. Topics to log are unique to each device. To view interval data logs, refer to Device Logging (*see page 76*) in **Monitoring** menu.

NOTE: To enable the **Device Logging** feature, there must be a time value selected from the **Logging Interval** drop-down list. It is recommended to disable the logging feature for the specific device being configured. To do this, clear the logging check box for the device being selected.

Logging

To disable logging, select the logging interval as **Disabled**, ensure that the logging selections are cleared, then click **Apply**.

Purge Data

To delete a data log, check **Purge Data** for the topics to be deleted.

Customize

To customize logging content, enable device logging. Click **Topics** under **Customize** for the device to be configured.

Device Log Export

Description

The **Device Log Export** page is used to export the device logs automatically by IFE server. The device log export allows you to configure IFE server to export device logs periodically. You can choose to export the device log files through email or FTP.

NOTE: If the email and the FTP servers are not located on the same Ethernet network segment as the IFE server, ensure that the IFE default gateway is properly configured.

Transport

Parameter	Description	Setting
Disabled	When Disabled is selected, either email or FTP is enabled.	–
Email	Allows you to choose the way of exporting the log files through email.	–
FTP	Allows you to choose the way of exporting the log files through FTP. NOTE: When FTP is selected, Test FTP is enabled.	–
Test FTP	Sends the text file to the FTP server configured in the FTP parameters. The text file contains the device information, and the device name with the date and time.	–
Incremental	Selects only the new interval data logged since the last successful data export. NOTE: <ul style="list-style-type: none"> • If the transport is scheduled for Hourly or Logging Interval, the incremental check box is selected automatically and is unavailable to be cleared. • If the Incremental check box is not selected, the complete log file is sent through an email as an attachment on each scheduled interval. 	–
Manual Export	Allows you to export the accumulated log files manually.	–

Schedule

Parameter	Description	Setting
Logging Interval	Selects how often the data logs are sent.	<ul style="list-style-type: none"> • Hourly • Daily • Weekly • Monthly • Logging Interval

To Addresses

Parameter	Description	Setting
To Addresses	Lists the email recipients configured in the IFE user accounts.	–

FTP Parameters

Parameter	Description	Setting
Server IP Addresses	Allows you to enter the FTP server IP address.	–
Server TCP Port	Allows you to enter the server port number.	–
Directory	Allows you to select the directory where you want the files to be saved.	–
Username	Allows you to enter the FTP username.	–
Password	Allows you to enter the FTP password.	–
Passive	Allows you to select the mode of FTP operation. NOTE: Passive mode is enabled by default.	–

SNMP Parameters

Manage IP Parameters

The IFE server supports SNMP, allowing a network administrator to access remotely an IFE server with an SNMP manager and to view the networking status and diagnostics of the IFE server in the MIB-II format.

Parameter	Description	Setting
Manager One	Allows you to configure the IP address of SNMP manager one.	–
Manager Two	Allows you to configure the IP address of SNMP manager two.	–
System Contact	Allows you to configure the SNMP system contact name.	–
System Name	Allows you to configure the system name.	–
System Location	Allows you to configure the SNMP system location.	–
Read-only Community Name	Allows you to configure the SNMP read-only community name.	Public (Factory setting)
Read-write Community Name	Allows you to configure the SNMP read-write community name.	Private (Factory setting)
Trap	Allows you to trap the community name.	Public (Factory setting)

NOTE: Only SNMP version 1 is supported.

Enabled Traps

Parameter	Description	Setting
Coldstart Trap	Generates a trap when the IFE server is powered ON.	–
Warmstart Trap	Not supported	–
Linkdown Trap	Generates a trap when an Ethernet port communication link is disconnected.	–
Linkup Trap	Generates a trap when an Ethernet port communication link is reconnected.	–
Authentication Failure Trap	Generates a trap when an SNMP manager is accessing the IFE server with incorrect authentication.	–

Preferences

General Settings

Parameter	Description	Setting
Equipment Name	Displays the equipment name. This name is used in the web interface banner. NOTE: The device name can be updated in the Name field of the Device Configuration submenu in the Configuration & Settings menu.	–
Real Time Sample Rate	Controls how often data is read from the device in the standard monitoring table views.	5–60 s Factory setting: 5 s
Communications Check Rate	Controls how often a communications check is performed while the browser is displaying real-time readings in the standard monitoring table views. This function attempts to bring any out-of-service devices back into service automatically.	5–30 min Factory setting: 5 min

Advanced Services Control

Industrial Protocol

Parameter	Description	Setting
Enable Modbus/TCP	Allows you to enable/disable the Modbus/TCP service.	<ul style="list-style-type: none">• Enabled (Factory setting)• Disabled

Services Configuration

Parameter	Description	Setting
Enable FTP server	Allows you to enable/disable the FTP service.	<ul style="list-style-type: none">• Enabled (Factory setting)• Disabled
Enable device announcement	Allows you to enable/disable the DPWS service.	<ul style="list-style-type: none">• Enabled (Factory setting)• Disabled
Enable SNMP	Allows you to enable/disable the SNMP service.	<ul style="list-style-type: none">• Enabled• Disabled (Factory setting)

User Accounts

Description

The IFE users are assigned with user names and passwords. Each user belongs to a group, and each group has access rights to the IFE webpages assigned by the IFE administrator.

NOTE: There are two pre-defined user accounts:

- Administrator (the default password is `Gateway`)
- Guest (the default password is `Guest`)

Groups

To change the group name, enter a new name in one of the group text boxes.

NOTE: The administrator group name cannot be changed.

Password

⚠ WARNING
POTENTIAL COMPROMISE OF SYSTEM AVAILABILITY, INTEGRITY, AND CONFIDENTIALITY
Change default passwords at first use to help prevent unauthorized access to device settings, controls, and information.
Failure to follow these instructions can result in death, serious injury, or equipment damage.

A password can be changed on the User Accounts webpage.

A password is composed of 0 to 11 characters. It is case-sensitive and the allowed characters are:

- Digits from 0 to 9
- Letters from a to z
- Letters from A to Z
- Special characters as *, /, \, etc.

NOTE: The password with eleven stars (******) is not allowed.

Users

Parameter	Description
Name	Enter a name (1 to 15 characters) for a new user. NOTE: User names are case-sensitive and can contain only alphanumeric characters.
Password	Enter a password (0 to 11 characters) for a new user.
Email ID	Enter a valid email address for the selected name.
Group	Select a group for the new user.
Language	Select the language for the new user and click the Apply button to view the webpages in the selected language. NOTE: When the administrator switches to a different language for the user account, make sure to refresh the webpage manually to display the webpages in a selected language.

NOTE: The maximum number of user-defined accounts are 11.

IFE Accounts and Passwords

Accounts	Password
Administrator	Gateway
Guest	Guest
User-defined accounts (11 accounts possible)	User-defined passwords

NOTE:

- You can change your password.
- If you forget the password, contact your local Schneider Electric service team for retrieving the password.

Webpage Access

Group Access

Group	Access
Administrator	Full access to all webpages. NOTE: It is recommended to change the default administrator password for system security the first time you log in.
Guest	Read-only access to selected webpages.
User-defined groups	Choosing from the following options, the administrator assigns webpage access for each group. The access levels are as follows: <ul style="list-style-type: none">● None: A group has no access to selected webpage● Read-Only: The password grants a group read-only access to the selected webpage● Full: A group has the same access as the administrator group to the selected webpage

NOTE:

- The **Webpage Access** is available for the **Administrator** only.
- The **Administrator** has full access to all the webpages.

Section 2.3

Monitoring Webpages

What Is in This Section?

This section contains the following topics:

Topic	Page
Real Time Data	74
Device Logging	76

Real Time Data

Description

The **Real Time Data** page provides:

- the basic readings of the selected devices in real time on **Single Device Pages**.
- the device summaries on **Summary Device Pages**.
- the real-time trending for the selected device for the selected topics on **Trending**.

NOTE: Refresh the webpage by action on the function key **F5** when out of service is displayed.

Single Device Pages

This page displays the basic readings of the selected devices on real-time basis. This includes circuit breaker health status with green, orange, and red indication, cradle status, load current, power, power factor, voltage, and so on.

The table shows the steps to monitor the real-time data of a device:

Step	Action	Result
1	From the IFE menu bar, click Monitoring .	Opens the Monitoring menu.
2	From the Monitoring menu, in the Real Time Data submenu, select a device from Single Device Pages .	Displays the real-time data of the selected device.

For BCPM devices, the auxiliary and branch circuit parameters can be monitored for real-time values. If you have Administrator privilege, you can modify or configure the circuit names for BCPM devices.

Summary Device Pages

The summary device table views provide summary of one or more selected devices.

Step	Action	Result
1	From the Monitoring menu, in the Real Time Data submenu, click Summary Device Pages .	Expands the tree for summary page selection choices.
2	Select the Summary Page to be viewed.	Opens the device selection list.
3	Select the devices from the Available Devices , then click Apply . NOTE: Click select all to select all the available devices. Click clear all to clear all the selected devices.	Summary of the selected device appears. NOTE: Click New selection to navigate back to the device selection list.

Trending

Step	Action	Result
1	From the IFE menu bar, click Monitoring .	Opens the Monitoring menu.
2	From the Monitoring menu, in the Real Time Data submenu, select Trending .	Expands the data tree for real-time data option selection and the time trending option selection.
3	Select Real Time Trending .	Opens the real-time trending setup page.
4	Select up to 4 devices from the Available Devices list.	Selects devices for trending.
5	Select the topics from the Available Topics list. NOTE: Only topics common to all selected devices are available for trending. The maximum number of topics to trend is dependent on the number of devices selected. The multiplication (product) of the selected devices and the selected topics must be 8 or less.	Selects topics for trending.
6	Click Apply to open the Real Time Trending display page.	Opens the real-time trending display page.
7	Set the trending parameters.	Allows trending parameters to be set.

Trending Parameters

Step	Action	Result
1	Select Absolute or Relative trending. NOTE: Absolute redraws the x-axis in the graph after each sample, filling it with all the data collected since the start of the trend. The Relative updates the graph with the latest data after each sample while the x-axis stays constant to show the overall trend time selected.	Selects graph mode.
2	Choose a trend time from 1–15 minutes. This is the duration of the trend. NOTE: Data samples are taken as fast as possible but may take longer depending on the communications load on the Modbus-SL port.	Selects the amount of time of the trend.
3	Select Start Sampling to start the trending of the selected device topics. NOTE: Trending may be stopped before reaching the trend time by clicking Stop Sampling . If Start Sampling is pressed after stopping the sampling, a new trend is started.	Starts trending.
4	Press Data Points to view a log of all the sampled topics recorded during the trend time.	Displays a log of all topic values sampled during the trend.
5	Press New Selection to reselect the devices and topics to trend.	Navigates back to the real-time trending setup page.

Device Logging

Introduction

The **Device Logging** page provides the graphic and table representations of the selected device log data. For more details on configuring device logging, refer to Device Logging ([see page 65](#)).

Single Device Pages

Step	Action	Result
1	From the IFE menu bar, click Monitoring .	Opens the Monitoring menu.
2	From the Monitoring menu, click Device Logging .	Expands tree to show available device logging choices.
3	From the Device Logging , click Single Device Pages .	Expands tree to show available devices that have logged data available for viewing.
4	Select a device from the Device List .	Displays the device log for the selected device.
5	To view a data range, select a period range from the period range drop-down list: <ul style="list-style-type: none"> ● Last Full Day ● Last Full Week ● Last Full Month ● All 	Plots the selected period range.
6	Hold the left mouse button and drag a selection box around a graph area to zoom in on it.	Zooms in on the selected graph area.
7	To return to the original full view, enter Z on your keyboard, or double-click the graph.	The view zooms out.
8	Click Data Points to view the selected interval data log table.	Opens the selected Interval Data Log table.
9	To view different topics, click New Topic(s) . Enable the check boxes of the topics to be displayed, and click Apply .	Enables the display of the selected topics.

The data logged from each device is displayed in a webpage in a time-trend chart format. The time-trend chart is preconfigured to display data from the **Last Full Day**, **Last Full Week**, **Last Full Month**, or **All**.

Energy parameters are logged as accumulating values but are displayed as incremental values on an interval basis. All other parameters are logged and displayed as the actual value recorded.

Retrieving a Data Log

Interval data logs can be retrieved using the methods given in the following table:

Retrieval Method	File Format Retrieved
IFE FTP server	Comma-separated variable (CSV)
Export to an external FTP server	CSV
Data point button	HTML
Email	CSV

To view the list of all the available log files, follow steps 2 to 4 in the section Getting an Interval Data Log using FTP ([see page 77](#)). Files are in the format: *Device Name.csv* where the device name is the name given to the slave device. For example, a device named building 1 utility entrance is *Building 1 Utility Entrance.csv*.

When the log files are exported, the date and time are appended to the file name in the following format: *_YYYYMMDDHHMMSS*. For example, *Building 1 Utility Entrance_20100218115216.csv*. This indicates that the file was exported on 2010 February 18 at 11:52:16 AM.

NOTE:

- The circuit breaker status in log file is coded by numbers. For information on circuit breaker status, refer to the description of the Modbus register 12001 in the Modbus Communication Guides ([see page 7](#)).
- The device log file may contain invalid values (-9999, -99999, 32768) for electrical parameters based on the data read from the device.

Log Format

Data is logged in the CSV file with the following format:

Row	Data in CSV Format	Description
1	IFE name, IFE serial number, IFE address, device name, device local ID, device type name, logging interval.	This row contains the column headings for the information in row 2.
2	IFE 555, 23227,157.198.184.116, building1 utility entrance, 893, MasterPact MTZ,15	This row contains the information about the IFE server and the logged device.
3	This row is blank.	–
4	,,,topic id 1,topic id 2,topic id 3	This row contains the column headings for the topic IDs in row 5. A topic ID is a numerical reference to the quantity being logged. Topic IDs are used to identify the quantity, regardless of the device or language. The first three commas are used for layout purposes in a spreadsheet application.
5	,,,1617,1621,1625	This row contains the topic IDs of the values logged.
6	This row is blank.	–
7	Error, UTC offset (Minutes), local time stamp, apparent energy (kVAh), real energy (kWh), reactive energy (kVARh)	This row contains the column headings for the data logged in rows 8 and higher.
8 and higher	These rows contain the logged data. 0,-300,2008-10-09 14:15:00,1400738.219,1201962.707,647069.906,15 0,-300,2008-10-09 14:20:00,1400758.260,1201980.725,647078.602,15 0,-300,2008-10-09 14:25:00,1400778.198,1201998.661,647087.233,15	

If a spreadsheet application is used to view the CSV file, data should look similar to the interval data log opened in a spreadsheet application.

Error Codes for Data Logs

The following error codes may be seen when troubleshooting data logs:

Error Code	Definition
19	Communication error occurred (for example: CRC, protocol, or exception).
25	Timeout occurred when a request was sent without receiving a corresponding response within the allowed time.
38	Invalid data.
100	Interval time expired before data could be recorded.
101	Invalid local time stamp. IFE is not set with absolute time.

Contact technical support if you need assistance in resolving these or other error conditions.

Retrieving Data Log Using IFE FTP Server

You can use IFE FTP server to retrieve a data log file by connecting to the IFE server via FTP and transferring the .csv file, as shown in the steps below.

NOTE: If you want the IFE server to send the data log file via FTP automatically, the device log export must be configured for FTP.

Step	Action	Result
1	Create a folder on your computer, such as C\:\file_logs.	Creates a folder to store the IFE data log.
2	Launch Windows Explorer, enter ftp:// and the IP address of the IFE server in the address text box (for example, ftp://169.254.0.10), press Enter .	Opens the Log On As dialog box.
3	Enter the user name as Administrator and password as Gateway in the text boxes, click Log On .	Opens an FTP session with the IFE server and displays the files stored in the IFE server.
4	Navigate to the directory /logging/data on the IFE server.	Opens the data logging directory on the IFE server.
5	Copy the log file and paste it into the folder created in step 1.	Copies the data log to the folder.

Retrieving Data Log Using the Data Points Button

Step	Action	Result
1	From the Device Logging webpage, click Data Points .	Opens a new window displaying the logged data.
2	Press CTRL+A , then press CTRL+C .	Selects all of the data and copies the data to the clipboard.
3	Open Excel, then press CTRL+V .	Pastes the data into an Excel spreadsheet.

Retrieving Data Log Using Email

The IFE server must be configured to deliver data logs to an email address. For more information, refer to Email Export (*see page 67*).

Summary Device Pages

The summary device view provides the summary of one or more selected devices.

Step	Action	Result
1	From the Monitoring menu, click Device Logging .	Expands the tree for device logging choices.
2	Under Device Logging , click Summary Device Page .	–
3	Under Summary Device Pages , click Single Topic for Multiple Devices .	Opens the setup page for the multiple devices, and single topic page for multiple devices.
4	Select a device from the Available Devices list. NOTE: A maximum of four devices may be selected.	Selects the devices for the summary options.
5	Select a topic from the Available Topics list. NOTE: Only topics that are common between the selected devices are available.	Selects the topic to display for each selected device.
6	Select Next .	Displays the Single Topic for Multiple Devices page.
7	Hold the left mouse button and drag a selection box around a graph area to zoom in on it.	Zooms in on the selected graph area.
8	To return to the original full view, enter Z on the keyboard, or double-click the graph.	The view zooms out.

The topic logged from the selected devices is displayed in a webpage in a time-trend chart format. The time-trend chart is preconfigured to display data from the last full day, last full week, last full month, or last 6 weeks.

Energy parameters are displayed as incremental values on an interval basis. All other parameters are logged and displayed as the actual value recorded.

Section 2.4

Control Webpages

What Is in This Section?

This section contains the following topics:

Topic	Page
Device Control	80
Set Device Time	83

Device Control

Reset Commands

The **Device Control** page allows you to execute one or more reset commands per device type. From the **Control** menu, in the **Device Control** submenu, on the device list, select the device and click **Reset**. Select an **Operation** in the **Resets** list to reset.

Application Control

The **Device Control** page allows you to control the following applications remotely:

- Breaker application
- IO application
- Acti9 Smartlink application

By default, this feature is disabled in IFE server.

Password Management

When the application control operation is performed, an **Authorization Required** dialog box appears in the IFE webpage. Enter the password in the **Authorization Required** dialog box to perform the application control operation.

The password required is for ComPact NSX circuit breaker with BSCM, MasterPact MTZ circuit breaker with MicroLogic X control unit, and MasterPact NT/NW or ComPact NS circuit breaker with BCM ULP.

The following operations in the **Device Control** page require a password:

Control	Operation	Availability
Breaker/Switch disconnecter (BCM-OF/SD)	Open/Close/Reset	ComPact NSX circuit breaker with BSCM
	Open/Close	<ul style="list-style-type: none"> ● MasterPact NT/NW or ComPact NS circuit breaker with BCM ULP ● MasterPact MTZ circuit breaker with MicroLogic X control unit
Light	On/Off	IO 1 or IO 2
Load	On/Off	IO 1 or IO 2
Reset input counters	I1 I2 I3 I4 I5 I6	IO 1
	#I1 #I2 #I3 #I4 #I5 #I6	IO 2
Reset output counters	O1 O2 O3	IO 1
	#O1 #O2 #O3	IO 2
User-defined output control	On/Off	IO 1 or IO 2

Enable Application Control in IFE Server

Follow the below procedure to enable the **Application Control** feature in IFE server.

NOTE: The application control feature can only be enabled when the user is logged in as an administrator.

Step	Action	Result
1	Press the test button on the front face of the IFE server for 10–15 s. NOTE: Do not press the test button less than 10 s or more than 15 s.	Initiates the application control feature.
2	After 15 s, IFE server initiates the application control feature.	The feature disclaimer window is available continuously for 5 min. The module status LED starts blinking continuously for 5 min (1 s ON, 1 s OFF) once the test button is released.
3	Access the IFE webpage and login as an administrator.	The administrator login to the IFE webpage.
4	From the Configuration & Settings menu, click Webpage Access .	The Administrator reads the disclaimer and chooses either the option I Understand the risks/Apply or Continue to disable . The application control feature disclaimer is: <i>By accepting this disclaimer, you are directed to webpage access which enables you to control several applications remotely. It is highly recommended that the administrator modify the default administrator password. By using, you are agreeing to indemnify and hold harmless Schneider Electric for and from any claims, losses, demands, lawsuits, and damages that are a result of direct or indirect use of this application control feature by reason of any act or emission which the user commits.</i> The disclaimer page is available in the language selected by the administrator.
5	Select I Understand the risks/Apply .	The application control feature is now enabled for the administrator. The breaker application and IO application are enabled in the webpage access for providing access to the other user groups.
6	Select Continue to disable .	The application control feature is disabled. The breaker application and IO application are disabled in the webpage access.

Breaker Application

From the **Device Control** page, in the **Breaker Application**, the authorized group can perform the following operations:

Control	Status	Operation	Availability
Breaker	Open/Close/Tripped/NA	Open/Close/Reset	ComPact NSX circuit breaker with BSCM
		Open/Close	<ul style="list-style-type: none"> ● MasterPact NT/NW or ComPact NS circuit breaker or switch disconnecter with BCM ULP ● MasterPact MTZ circuit breaker with MicroLogic X control unit

NOTE: Pop-up message confirms that the command is successfully sent. It does not confirm whether the complete operation is successful.

IO Application

From the **Device Control** page, in the **IO Application**, the authorized group can perform the following operations:

Control	Status	Operation	Availability
Reset input counters	-	I1 I2 I3 I4 I5 I6	IO 1
		#I1 #I2 #I3 #I4 #I5 #I6	IO 2
Reset output counters	-	O1, O2, O3	IO 1
		#O1 #O2 #O3	IO 2
Light control	ON or OFF	ON / OFF	IO 1 or IO 2
Load control	ON or OFF	ON / OFF	IO 1 or IO 2
User-defined output control	ON or OFF	ON / OFF	IO 1 or IO 2

NOTE:

- The IO application control is possible only when the IO module is connected to a circuit breaker.
- The light and the load control are available when the application rotary switch of IO 1 or IO 2 is in position 4.
- The user-defined output control is available only when the user-defined output has been assigned with Ecoeach software.
- If the input is assigned as a pulse counter, the operation is P1, P2, P3, P4, P5, and P6 for IO 1. For IO 2, the pulse counter operation is #P1, #P2, #P3, #P4, #P5, and #P6.

Acti9 Smartlink Application

From the **Device Control** page, in the **Acti9 Smartlink**, the authorized group can perform the following operations:

Control Device	Status	Operation	Availability
Reflex	Open/Close/Off	Open/Close	Reflex iC60
RCA	Open/Close/Trip	Open/Close	RCA iC60
Contactors/Impulse Relay	Open/Close/Device disconnected	Open/Close	iACT24/iATL24

Set Device Time

Description

The **Set Device Time** page allows you to synchronize the date and time of the slave devices connected to the IFE server to IFE date and time. It also allows you to get the device time that are connected to the IFE server. This page lists the slave devices that require an external interface to set their date and time.

List of Parameters in Set Device Time

Parameter	Description
Device Selection	Allows you to select the device from the list for synchronizing, getting, and synchronizing the time.
Localized Time	Displays the time of the selected device.
Status	Displays the status of the selected device.
Get Time	Allows you to get the time of the selected device.
Set Device Time	Allows you to set the time of the selected device.

Setting the Device Time

Step	Action	Table
1	From the IFE menu bar, click Control .	Opens the Control menu.
2	From the Control menu, click Set Device Time .	Opens the Set Device Time page.
3	Select the devices from the Set Device Time page, and then click Set Device Time .	<p>The selected slave device date and time gets synchronized with the IFE time and the status is updated as successful.</p> <p>NOTE: If the selected device fails to synchronize with IFE date and time, then the status is updated as unsuccessful.</p> <p>NOTE: Set Device Time feature is not applicable for IFE's own IMU and shows the set status as NA (Not Applicable).</p>

Section 2.5

Diagnostics Webpages

What Is in This Section?

This section contains the following topics:

Topic	Page
Statistics	85
Device Identification	87
IMU Information	88
Read Device Registers	89
Communication Check	90
IO Readings	91

Statistics

Description

The **Statistics** page shows the readings accumulated since the IFE server was last activated. If the power to the IFE server is terminated or the device is reset due to a configuration change or other event, all cumulative values are reset to 0.

Reset Procedure

Step	Action	Result
1	From the IFE menu bar, click Diagnostics .	Opens the Diagnostics menu.
2	From the Diagnostics menu, in the General submenu, click Statistics .	Opens the Statistics page.
3	View the data.	See the statistics for each group.
4	Click Reset Counters .	Resets the IFE cumulative diagnostic data to 0.

Interpreting Ethernet Statistics

Global Statistic	Description
Received Frames	Number of frames received
Transmitted Frames	Number of frames transmitted
Reset Counters	Resets the transmitted and received frames

Statistic Per Port	Description
Link Speed	Operational speed (10 Mbps or 100 Mbit/s)
Duplex mode	Current mode of operation (full duplex or half duplex)

Interpreting Modbus TCP/IP Statistics

Statistic	Description
Port status	Status of the connected Ethernet port
Opened TCP connections	Number of active connections
Received messages	Number of messages received
Transmitted messages	Number of messages transmitted
Reset counters	Resets the received and transmitted messages

Interpreting System Statistics

Statistic	Description
CPU	Status of the CPU: <ul style="list-style-type: none"> ● Nominal ● Degraded ● Out of service
Boot Memory	Healthiness of the boot memory
EEPROM	Healthiness of EEPROM
File System	Healthiness of the file system
Ethernet PHY 1	Healthiness of PHY 1 hardware
Ethernet PHY 2	Healthiness of PHY 2 hardware
DDR	Healthiness of the execution memory

Interpreting Date and Time Statistics

Statistic	Description
Date	Current date
Time	Current time
Uptime	Run time during the system power-up

Interpreting Date /Time Synchronization

Statistic	Description
Last Synchronization	
Last Synchronization Since	Time elapsed since the last synchronization has happened
Time Source	Source of time with which the last synchronization has happened
Date	Last synchronization date
Time	Last synchronization time
Synchronization with SNTP	
Status	The following is the status of synchronization with SNTP: <ul style="list-style-type: none"> ● If SNTP is disabled, the status is displayed as “-” ● If SNTP is enabled but not synchronized, then the status is displayed as “NOK” ● If SNTP is enabled and successfully synchronized, then the status is displayed as “OK”

Interpreting Modbus Serial Statistics

Statistic	Description
Transmitted Message	A counter that increments each time a frame is sent.
Received Message	A counter that increments each time a frame is received.
Error Message	An error marked from the slave or the response timeout.

Interpreting ULP Statistics

Statistic	Description
Frames Transmitted	Number of CAN frames transmitted successfully
Frames Received	Number of CAN frames received successfully
Max Transmit Error	Maximum number of CAN transmitted errors (TEC)
Max Receive Error	Maximum number of CAN received errors (REC)
Bus off	CAN Bus off count
Max Bus off	Maximum number of bus off counts

Interpreting File System Statistics

Statistic	Description
Total Size	Total amount of the IFE disk size in kilobytes
Used Size	Total amount of used disk size on the IFE disk in kilobytes
Free Size	Total amount of unused disk space on the IFE disk in kilobytes
Bad Size	Amount of corrupted disk space on the IFE disk in kilobytes

Interpreting TCP Port Connections Statistics

Statistics	Description
Remote IP	Remote IP address
Remote Port	Remote port number
Transmitted messages	Number of messages transmitted
Received message	Number of messages received
Sent Errors	Number of error messages sent
Reset Counters	Resets the transmitted and received messages

Device Identification

Device Name Configuration Procedure

Step	Action	Result
1	From the IFE menu bar, click Diagnostics .	Opens the Diagnostics page.
2	From the Diagnostics menu, in the Product Information submenu, click Device Identification .	Opens the Device Identification page.

List of Parameters in Device Identification

Parameter	Description
Device name	Device name which is updated in the device name field
Product name	Name of the product
Serial number	Device serial number
Product model number	Device model number
Firmware version	Current firmware version
Unique Identifier	Combination of MAC address and the time
MAC address	Unique MAC address
IPv4 address	IP address of the IFE server
IPv6 link local address	Address used to communicate on the local network

IMU Information

Description

The **IMU Information** page gives the information about the devices which are connected to the ULP port of the IFE server. The devices connected are:

- BCM ULP module
- MicroLogic trip unit
- BSCM module
- FDM121 display
- IO module IO 1
- IO module IO 2
- UTA module

Read Device Registers

Description

Read device registers allows the IFE server to read Modbus registers from the selected device.

Read Procedure

Step	Action	Result
1	From the IFE menu bar, click Diagnostics .	Opens the Diagnostics menu.
2	From the Diagnostics menu, in the Device Health Check submenu, click Read Device Registers .	Opens the Read Device Registers page.
3	From the Device Name , select the device.	Selects the device from the drop-down list.
4	Enter Local ID (or choose from the defined device list), Starting Register , and the Number of Registers to read.	Enters the registers to read from the specified device.
5	Select the data type from Data Type drop-down list.	Selects the appropriate data type.
6	To change how Modbus data is displayed in the Value column, select Decimal , Hexadecimal , Binary , or ASCII .	Selects how the data values are displayed.
7	Click Read .	Reads the device registered according to the selected configuration.

IFE Read Device Register Parameters

Parameter	Description	Settings
Device Name	Selects a device to read from the list of previously added devices. The slave device of a master IFE server not defined in the device list can be read by entering its local ID number. NOTE: The slave device of a remote device not defined in the device list cannot be read by entering its local ID number.	–
Local ID	The address (local ID) of the device that is to be read.	1
Starting Register	Register number in decimal.	0–65535 Factory setting: 1000
Number of Registers	The number of registers to read.	1–125 Factory setting: 10
Register	Lists the register numbers in decimal.	–
Value	Lists the data stored for a register. Values retrieved depend on the device connected to the IFE server. Refer to the documentation for the connected device for more information about stored register values.	–
Data Type	Lists the data types available for the device.	<ul style="list-style-type: none"> ● Holding Registers (Factory setting) ● Input Registers ● Input Coils ● Output Coils
Decimal, Hexadecimal, Binary, or ASCII options	Select an option to specify how the value column data is displayed.	Decimal (Factory setting)

Communication Check

Automated Communication Check

While browsing the real-time data views, the IFE server has an automated communication check that runs every 15 minutes by default. To change the timing, refer to Preferences (*see page 69*). This check verifies the communication health of all the devices configured on the IFE server, and attempts to re-establish the communication to any device marked out of service within the current browser session.

Manual Communication Check

In certain cases, there is no need to wait for the automated communications check interval and need to force the check to run manually.

Step	Action	Result
1	From the IFE menu bar, click Diagnostics .	Opens the Diagnostics menu.
2	From the Diagnostics menu, in the Device Health Check submenu, click Communications Check .	Opens the Communications Check page.
3	Click Check Device Status .	<p>Runs a communications check.</p> <p>The communicating device displays:</p> <ul style="list-style-type: none"> ● Passed in the Communications column. ● In Service in the Status column. <p>A device that is not communicating display:</p> <ul style="list-style-type: none"> ● Failed in the Communications column. ● Out of Service in the Status column if it has failed multiple times.

IO Readings

Description

The **IO Readings** page shows the IO module input/output configuration. It displays six digital inputs, three digital outputs, and one analog input. The IO application control is possible only when the IO module is connected to a circuit breaker.

The table shows the steps to access the **IO Readings** page:

Step	Action	Result
1	From the IFE menu bar, click Diagnostics .	Opens the Diagnostics page.
2	From the Diagnostics menu, select a device from IO Readings submenu.	Opens the IO Readings page for the selected device.

List of Parameters in IO Module

Parameter	Description	Setting
Inputs	Displays the six digital inputs configured in the IO module.	–
Outputs	Displays the three digital outputs configured in the IO module.	–
Analog Inputs	Displays the analog input assigned in the IO module.	–
Label	Displays the assigned functions of the corresponding inputs or outputs.	–
Value	Displays the value of the six digital inputs and three digital outputs	<ul style="list-style-type: none"> ● 1 ● 0
Force/Unforce	Displays the six digital inputs and three digital outputs are forced or unforced	<ul style="list-style-type: none"> ● UNFORCED ● FORCED

Section 2.6

Maintenance Webpages

What Is in This Section?

This section contains the following topics:

Topic	Page
Indicators	93
Restore the Smartlink Modbus Devices	94

Indicators

Description

The **Indicators** page provides the maintenance counter information for the selected device. The page displays the information about the remaining service life of the circuit breaker, contact wear counters, circuit breaker operation counters, and the cradle counters.

Viewing Maintenance Counters

Step	Action	Result
1	From the IFE menu, click Maintenance .	Opens the Maintenance page.
2	From the Indicators menu, select the device from the device list. NOTE: This feature is available for circuit breakers only.	Displays the information about the remaining service life of the circuit breaker, contact wear counters, circuit breaker operation counters, and the cradle counters.

Restore the Smartlink Modbus Devices

Description

The **Restore** submenu allows you to move the configuration settings from the IFE server to the Smartlink Modbus device. The page displays the information about the device name, device type, and device status.

NOTE: The **Restore** submenu is available only for:

- IFE firmware versions that are less than or equal to V001.009.008.
- Smartlink Modbus devices and the IFE firmware versions that are equal to or greater than the versions listed in the system compatibility table for Smart Panels 1.1 and later.

Restore Page Parameters

Parameter	Description	Settings
Check box	Allows you to select the desired Smartlink Modbus device to restore the configuration in the Smartlink Modbus device.	<ul style="list-style-type: none"> ● Selected ● Cleared <p>NOTE: The check box is unavailable if the Smartlink Modbus device is not connected or the Smartlink Modbus device has incompatible firmware version</p>
Remote Gateway Name	Displays the name of the IFE server.	–
Name	Displays the name of the Smartlink Modbus device entered in the device list.	–
Device Type	Displays the device type selected for the Smartlink Modbus device in the device list.	–
Status	Displays the restore status of the Smartlink Modbus device.	<ul style="list-style-type: none"> ● OK ● Not OK : Incompatible version ● Not OK : Communication Failure
Restore	Allows you to restore the configuration in the Smartlink Modbus devices.	–

Restoring the Smartlink Modbus Device Configuration

Step	Action	Result
1	From the IFE menu bar, click Maintenance .	Opens the Maintenance menu.
2	From the Maintenance menu, click Restore the Smartlink's submenu.	Displays the Device to be restored page.
3	From the Device to be restored page, select the Smartlink Modbus devices to restore the configuration.	Selects the desired Smartlink Modbus devices to restore the configuration.
4	Click Restore .	Restoration Confirmation dialog box appears.
5	Click OK .	Configuration is restored in Smartlink Modbus devices from IFE server.

Appendices



Appendix A

Appendix A - List of IFE Supported Devices

List of IFE Supported Device Types

IFE Server Supported Slave Devices

The following table gives the list of devices that can be connected as Modbus slaves on an IFM interface stacked to the IFE server. This list of supported devices was accurate at the time this document was published. Check www.schneider-electric.com for updates.

Device Group	Device
MasterPact NT/NW, ComPact NS, and PowerPact P- and R-frame circuit breakers with MicroLogic trip units	MicroLogic A
	MicroLogic E
	MicroLogic P
	MicroLogic H
MasterPact MTZ circuit breaker with MicroLogic X control unit	MicroLogic X
ComPact NSX and PowerPact H-, J-, and L-frame circuit breakers with MicroLogic trip units	ComPact NSX-A
	ComPact NSX-E
	PowerPact - A
	PowerPact - E
Insulation monitoring devices	Vigilohm IM20
	Vigilohm IM20-H
Monitoring and protection relay	Vigirex RHU
Monitoring relay	Vigirex RMH
Power factor controller	Varlogic
Power meters	PM1200
	PM3250
	PM3255
	PM5000
	PM5100/PM5300
	PM5350
	PM5560
	PM800
	PM800 A-S1/A-S2
PM9C	

Device Group	Device
Energy meters	EM3550
	EM3555
	EM6400
	EM6430
	EM6433
	EM6434
	EM6436
	EM6436D
	EM6438
	EM6459
	iEM3150
	iEM3155
	iEM3250
	iEM3255
	iEM3350
iEM3355	
BCM-OF/SD	Non-communicating MasterPact NT/NW and ComPact NS circuit breaker and switch disconnecter
BSCM-OF/SD	Non-communicating ComPact NSX circuit breaker and switch disconnecter
Others	Acti9 Smartlink Modbus
	Acti9 Smartlink Ethernet
	Acti9 Smartlink SI B
	Acti9 Smartlink SI D
	PowerTag energy sensors (iEM1520, iEM1521, iEM1522, iEM1540, iEM1541, and iEM1542) IFE reads PowerTag energy sensor configuration from Acti9 Smartlink SI B and Acti9 Smartlink SI D device.
	BCPM A/E
	BCPM B
	BCPM C



DOCA0084EN-08

Schneider Electric Industries SAS

35, rue Joseph Monier
CS30323
F - 92506 Rueil Malmaison Cedex

www.schneider-electric.com

As standards, specifications and designs change from time to time, please ask for confirmation of the information given in this publication.